

MINIMAX



MiniMax User Guide

Mobile Aluminium Trade
Quality Access Tower System

3T - Through the Trapdoor Method

INSTRUCTION MANUAL
Edition July 2015

Safety First

Mobile Towers - 3T Method

INTRODUCTION

Please read this guide carefully.

Please note that diagrams are for illustrative purposes only.

User guides are also available to download from our website at youngmangroup.com

This User Guide provides you with step by step instructions to ensure your system is erected easily and safely, using the 3T (Through The Trapdoor) method.

The law requires that personnel erecting, dismantling or altering towers must be competent. Any person erecting a Youngman MiniMax mobile tower must have a copy of this guide. For further information on the use of mobile access and working towers follow the PASMA operators code of practice.

If you need further information, design advice, additional guides or any other help with this product, please contact Youngman on +44 (0)1621 745900 or email youngman-sales@wernerco.com

COMPLIANCES

The MiniMax aluminium system has been tested and certified to EN 1004: 2004 Class 3



EN 1004:2004



Typkontrollerad
SPCR 064
enligt Arbetsmiljöverket
AFS 1990:12

Instruction Manual
EN 1298-IM-EN

RISK ASSESSMENT

Please ensure that you arrived at the decision to use this product by carrying out a complete risk assessment. For more details please visit our website at youngmangroup.com where you can download a Risk Assessment Form and instructions on how to use it. You can also complete our interactive risk assessment on our website and print the results.

Safety First

PREPARATION AND INSPECTION

Inspect the equipment before use to ensure that it is not damaged and that it functions properly. Damaged or incorrect components shall not be used.

SAFE USE

- Check that all components are on site, undamaged and that they are functioning correctly – (refer to Checklist and Quantity Schedules). Damaged or incorrect components shall not be used.
- Check if the ground on which the mobile access tower is to be erected and moved is capable of supporting the tower.
- Towers must be climbed from the inside during assembly and use.
- It is recommended that towers should be tied to a solid structure when left unattended.
- Adjustable legs should only be used for levelling and not gaining extra height.

LIFTING OF EQUIPMENT

- Tower components should be lifted using a reliable lifting material (e.g. strong rope), employing a reliable knot (e.g. clove hitch), to ensure safe fastening and always lift within the footprint of the tower.
- Assembled mobile towers should not be lifted with a crane or other lifting device.

Safety First

MAXIMUM SAFE WORKING LOADS

- The Maximum Safe Platform Load on each platform (the combined weight of the users, tools and materials) is 220kgs.
- The Maximum Safe Tower Load (the combined weight of the users, tools and materials) for the complete tower is the Maximum Tower Load (500kgs) less the self weight of the tower.
- Loads within the Maximum Safe Tower Load but in excess of the Maximum Safe Platform Load (220kgs) must be distributed over 2 platforms
- All loads must be evenly distributed over the platform(s)

Composite code	380606	380609	380617	380637	380658
Working height (m)	2.6	2.8	3.7	5.7	7.8
Platform height (m)	0.6	0.87	1.65	3.7	5.8
Self Weight of Towers Kgs	(34 ^a) 41	(42 ^a) 48	[56 ^b] 79	120	174
Maximum Safe Tower Load Kgs	{200 ^c }	{200 ^c }	{200 ^c }	380	326

Notes

- (a) Figures in brackets ^(a) are weight excluding toeboards.
- [b] Figures in brackets ^[b] are weight excluding stabilisers - internal use only.
- {c} Load in brackets ^{c} are limited by number of platforms.

All figures exclude weight of adjustable legs. Deduct 5 kgs from maximum Safe Tower Load when using 4 adjustable legs.

IMPORTANT

- **The Maximum Safe Tower load is the total combined load of the users, tools, and materials.**
- **The Maximum Safe Platform load that can be placed on any 1 platform in a tower is 220kg which must be evenly distributed over the platform.**
- **Where there is only 1 platform in a tower, the Maximum Safe Tower load is limited to 220kgs.**

Safety Checklist

Mobile Towers - 3T Method

CHECKLIST

- Ensure all brace claws operate and lock correctly prior to erection
- Inspect components prior to erection
- Inspect tower prior to use
- Tower upright and level
- Castors locked and legs correctly adjusted
- Diagonal braces fitted
- Stabilisers/outriggers fitted as specified
- Platforms located and windlocks on
- Toeboards located
- Check guardrails are fitted correctly. See illustration below.

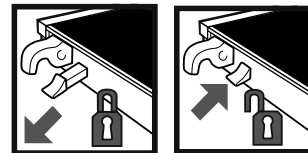
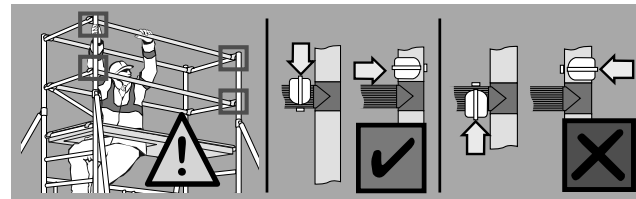

Ensure horizontal braces and guardrails are fitted correctly. Always fit as shown.

Refer to this checklist before using each time.

Safety First

STABILISERS/BALLAST

- Stabilisers or outriggers and ballast weights shall always be fitted when specified.
- When using the 1.7m tower externally, 4 SP7 stabilisers (small) must be fitted.
- The Quantity Schedules show the recommended stabilisation. In circumstances where there is restricted ground clearance for stabilisers/outriggers, contact your supplier for advice. Ballast must be of solid materials (i.e. not water or loose sand) and should not be positioned to overload individual legs. Ballast should be secured against accidental removal where practicable, and be supported on the lowest rung of the bottom frame.

MOVEMENT

- The tower should only be moved by manual effort, and only from the base.
- When moving the tower, beware of live electrical apparatus, particularly overhead, plus wires or moving parts of machinery.
- No person or materials should be on the tower during movement.
- Caution should be exercised when wheeling a tower over rough, uneven or sloping ground, taking care to unlock and lock castors. If stabilisers are fitted, they should only be lifted a maximum of 25mm above the ground to clear ground obstructions.
- The overall height of the tower when being moved, should not exceed 2.5 times the minimum base dimensions, or 4 metres overall height.
- Before use, check the tower is still correct and complete.
- After every movement of the tower use a spirit level to check that it is vertical and level and set the adjustable legs as required.
- Do not move the tower in wind speeds over 7.7 metres per second (17mph).

Safety First

DURING USE

Beware of high winds in exposed, gusty or medium breeze conditions. We recommend that in wind speeds over 7.7 metres per second (17 mph), cease working on the tower and do not attempt to move it. If the wind becomes a strong breeze, expected to reach 11.3 metres per second (25 mph), tie the tower to a rigid structure. If the wind is likely to reach gale force, over 18 metres per second (40 mph), the tower should be dismantled.

Wind Description	Beaufort Scale	Beaufort No.	Speed in m.p.h	Speed in m/sec
Medium Breeze	Raises dust and loose paper, twigs snap off	4	8-12	4-6
Strong Breeze	Large branches in motion, telegraph wires whistle	6	25-31	11-14
Gale Force	Walking is difficult	8	39-46	17-21

- Beware of open ended buildings, which can cause funnelling effect.
- Do not abuse equipment. Damaged or incorrect components shall not be used.
- Raising and lowering components, tools, and/or materials by rope should be conducted within the lower base. Ensure that the safe working load of the supporting decks and the tower structure is not exceeded.
- The assembled tower is a working platform and should not be used as a means of access or egress to other structures.
- Beware of horizontal forces (e.g. power tools) which could generate instability. **Maximum horizontal force 20 kg.**
- Mobile towers are not designed to be suspended - please refer to your supplier for advice.
- Do not use boxes or stepladders or other objects on the platform to gain extra height.

Safety First

TIES

- Ties should be used when the tower goes beyond its safe height, beyond the limits of the stabilisers/ outriggers, or if there is a danger of instability. They should be rigid, two way ties fastened to both uprights of the frame with load-bearing right angled or swivel couplers. Only couplers suitable for the 50.8mm diameter tube of the tower should be used. Ideally, ties should be secured to both faces of a solid structure by means of anchorages.
- The tie frequency may vary depending on the application, but they should, at a minimum, be every 4 metres height.
- For further information on tying-in a tower please contact your supplier or Youngman.

MAINTENANCE - STORAGE - TRANSPORT

- All components and their parts should be regularly inspected to identify damage, particularly to joints. Lost or broken parts should be replaced, and any tubing with indentation greater than 5mm should not be used and put to one side for manufacture repair. Adjustable leg threads should be cleaned and lightly lubricated to keep them free running.
- Brace claws, frame interlock clips, trapdoor latches and platform windlocks should be regularly checked to ensure they lock correctly.
- Components should be stored with due care to prevent damage.
- Ensure components are not damaged by excessive strapping forces when transported.

Components

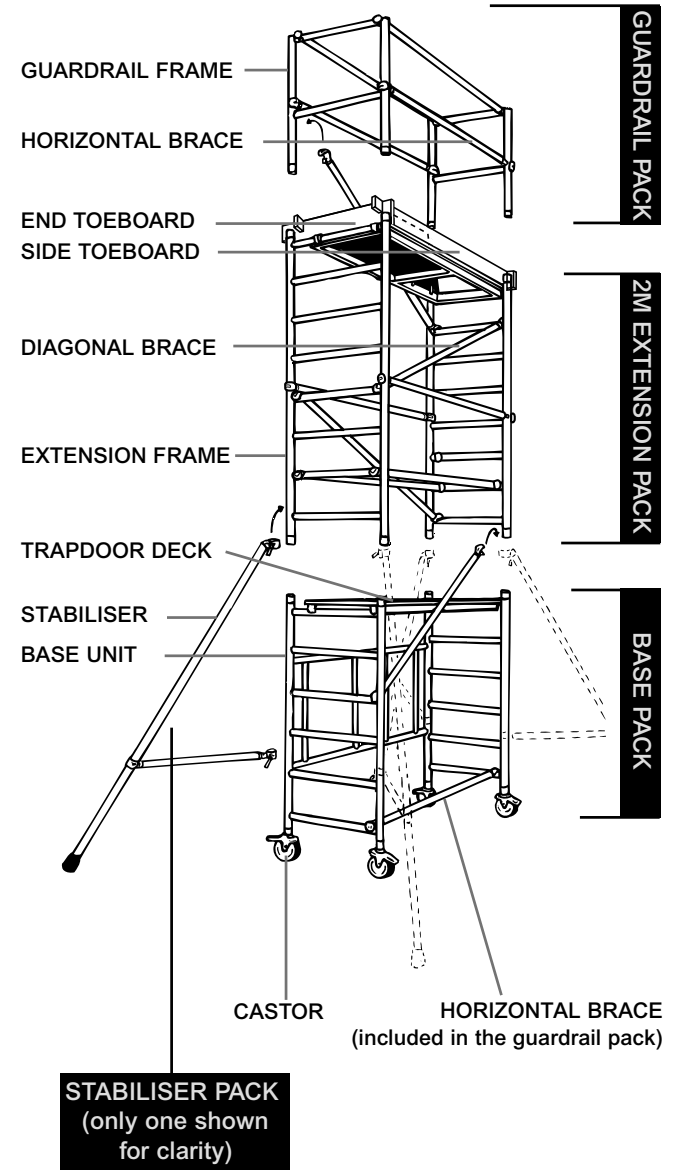

Quantity Schedule

QUANTITY SCHEDULE IN PACKS

MiniMax Tower to EN1004: 1.83m platform Length

Internal/External Use

Composite Code	380606	380609	380617	380637	380658
Working Height (m)	2.6m	2.8m	3.7m	5.7m	7.8m
Platform Height (m)	0.6m	0.9m	1.7m	3.7m	5.8m

Product Code	Description	Weight	Pack Quantities				
370518	Base Pack	34kg	1	1	1	1	1
372519	1 rung Guardrail Pack	8kg		1			
372518	2 rung Guardrail Pack	16kg			1	1	1
341518	2m Extension Pack	47kg				1	2
317513	SP7 Stabiliser (Small)	3.8kg ea			4 ^a	4	
318513	SP10 Stabiliser (Medium)	9kg ea					4
379518	Adjustable Leg Pack ^b	5kg	1	1	1	1	1
394518	Toeboard Pack	5kg	1 ^c	1 ^c	1	1	1

QUANTITY SCHEDULE IN COMPONENTS

MiniMax Tower to EN1004: 1.83m platform Length

Internal/External Use

Composite Code	380606	380609	380617	380637	380658
Working Height (m)	2.6m	2.8m	3.7m	5.7m	7.8m
Platform Height (m)	0.6m	0.9m	1.7m	3.7m	5.8m

Product Code	Description	Component Quantities				
000600	Folding Base Frame	1	1	1	1	1
377518	Trapdoor Platform	1	1	1	2	3
000616	8 Rung Frames				2	4
000610	Diagonal Braces			1	4	7
000621	Horizontal Braces		3	5	9	13
576917	Minimax Side Toeboard	2 ^c	2 ^c	2	2	2
000622	Minimax End Toeboard	2 ^c	2 ^c	2	2	2
399518	1 rung Guardrail Frames		2			
000618	2 rung Guardrail Frames			2	2	2
317513	SP7 Stabiliser (Small)			4 ^a	4	
318513	SP10 Stabiliser (Medium)					4
379518	Adjustable Legs ^b	4	4	4	4	4

a Only required for external use.

b Adjustable Legs only required if ground is uneven or sloping.

c Toeboards required if risk assessment shows necessary.

FITTING ADJUSTABLE LEGS

If the ground is uneven or sloping you will need to fit adjustable legs.

Turn the base unit upside down so that the wheels are facing upwards. We recommend that two persons are required to ease the process.

Using a 19mm spanner loosen the fixing bolt and remove the castor from the base.



Follow the instructions in the Adjustable Leg pack to change the large castor spigot to the smaller one supplied in the pack. Insert the new castor into an adjustable leg and then retighten the fixing bolt with the spanner, following the instructions. Repeat this process for the other castors and adjustable legs. Insert the four leg and castor assemblies into the base unit.

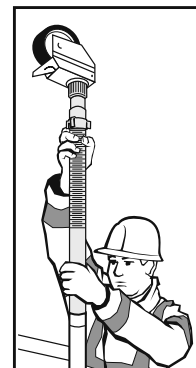

Turn the base the correct way up with the wheels on the ground.

Use a spirit level to check the base unit is level. Adjust the legs as necessary, to level the base unit.

IMPORTANT: Only use the adjustable legs to level the base and not to gain extra height.

Assembly Procedure

STAGE 1

COMPOSITE CODE 380606

MAXIMUM PLATFORM HEIGHT 0.6M

MAXIMUM WORKING HEIGHT 2.6M

- **1 BASE PACK**
- **1 ADJUSTABLE LEG PACK**
(required if ground is uneven or sloping)
- **1 TOEBOARD PACK**
(required where a risk assessment shows Toe Boards are necessary)

SETTING UP THE BASE UNIT



- 1** Move the base unit into the required position and unfold the end frames.

Push the central folding frame outwards until the two middle hinged joints lock in the open position. Check the trigger on both hinge joints has moved outwards to the locked position.

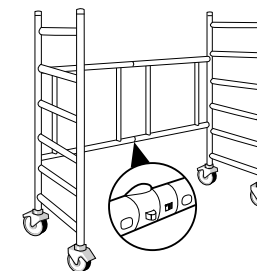

Assembly Procedure

Lock the brakes on all four castors wheels. Ensure the castors are facing outwards from the base unit.

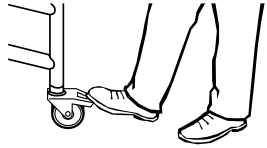

Check that the ground is flat and all four castor wheels are in contact with the ground. Use a spirit level to check the base is level. If the ground is uneven or sloping you will need to fit adjustable legs. See Fitting Adjustable Legs.

2 Position the platform at the required height on the rungs of the base unit end frames.

Do not position the platform above the 2nd rung. Engage the windlocks, underneath the rungs, at both ends of the platform.



Climb onto the platform in the sequence shown.

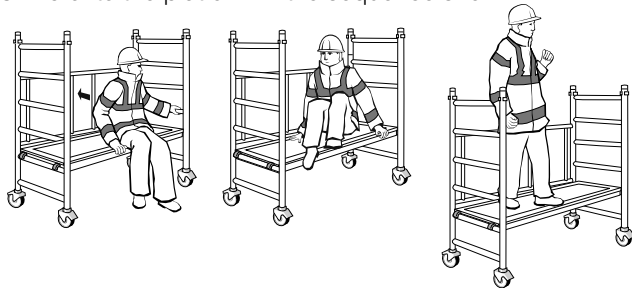

IMPORTANT:

Never climb up the outside of the Base Unit
Never over reach - get down and reposition the Base Unit.

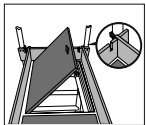

If your risk assessment shows it is necessary, fit toe boards to the platform checking that there are no gaps. See section FITTING TOEBOARDS

Assembly Procedure

STAGE 2

COMPOSITE CODE 380609
MAXIMUM PLATFORM HEIGHT 0.9M
MAXIMUM WORKING HEIGHT 2.9M

- **1 BASE PACK**
- **1 ADJUSTABLE LEG PACK**
(required if ground is uneven or sloping)
- **1 BASE UNIT GUARDRAIL PACK (1 RUNG)**
(required where a risk assessment shows a Base Pack guardrail is necessary)
- **1 TOEBOARD PACK**
(required where a risk assessment shows Toe Boards are necessary)

If a risk assessment shows that it is necessary to guardrail the platform at heights up to 0.9m, you will require a 1 Rung Guardrail pack.

Follow Stage 1 - Step 1 - Setting Up the Base Unit

If the ground is uneven or sloping you will need to fit adjustable legs. See Fitting Adjustable Legs.

2 Fit the 4 spring interlock clips supplied with the Guardrail Pack. Expand the clips over the top of the base unit uprights and then slide down to engage the pin on the clip into hole in the upright.

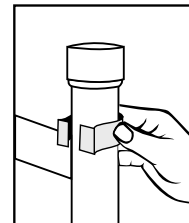
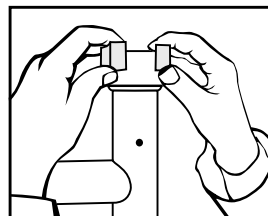

Assembly Procedure

Fit a 1 Rung Guardrail Frame at each end of the base unit. Ensure the 4 frame interlock clips are engaged.

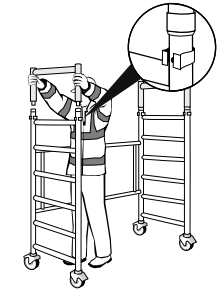

3 Fit a horizontal brace to the top rungs of the guardrail frame, on the folding side of the tower.

IMPORTANT: Always ensure braces are fully locked in position.

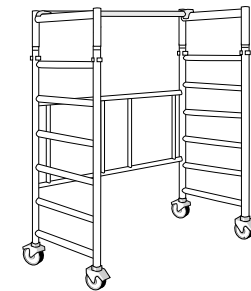

4 Position the platform at the required height on the rungs of the base unit.

Do not position the platform above the 3rd rung.
Engage the windlocks, underneath the rungs, at both ends of the platform.



Assembly Procedure

Climb onto the platform in the sequence shown
From the seated position, fit horizontal braces as guardrails on the 5th and 7th rungs, on the open side of the base unit. Do not stand on the platform until the guardrails are in place.

IMPORTANT: Always ensure braces are fully locked in position.

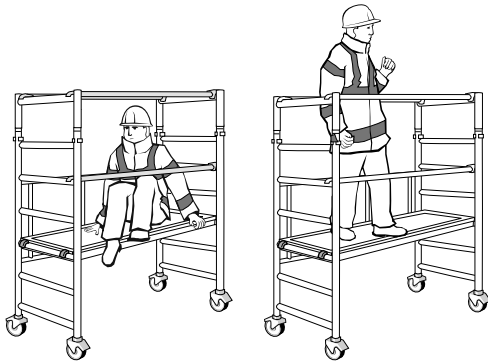

IMPORTANT:

Never climb up the outside of the Base Unit
Never over reach - get down and reposition the Base Unit platform.

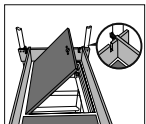

If your risk assessment shows it is necessary, fit toe boards to the platform checking that there are no gaps. See section FITTING TOEBOARDS

Assembly Procedure

STAGE 3

COMPOSITE CODE 380617
MAXIMUM PLATFORM HEIGHT 1.7M
MAXIMUM WORKING HEIGHT 3.7M

- **1 BASE PACK**
- **1 ADJUSTABLE LEG PACK**
(required if ground is uneven or sloping)
- **1 GUARDRAIL PACK**
(2 RUNG)
- **2 SP7 STABILISER (SMALL) PACKS**
(2 stabilisers per pack) for External Use Only.
- **1 TOE BOARD PACK**
(required where a risk assessment shows Toe Boards are necessary)

Follow Stage 1 - Step 1 - Setting Up the Base Unit

If the ground is uneven or sloping you will need to fit adjustable legs. See Fitting Adjustable Legs.

- 2** Fit a horizontal brace between the bottom rungs on the front face of the base unit. **IMPORTANT:** Always ensure braces are fully locked in position.

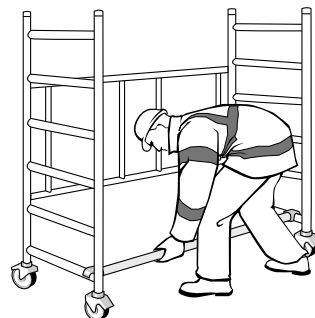

Assembly Procedure

- 3** Fit the 4 spring interlock clips supplied with the Guardrail Pack. Expand the clips over the top of the base unit uprights and then slide down to engage the pin on the clip into hole in the upright.

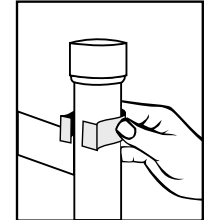
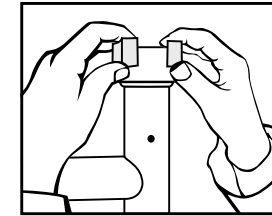

Fit a 2 rung guardrail frame at each end of the base unit. Ensure the 4 frame interlock clips are engaged

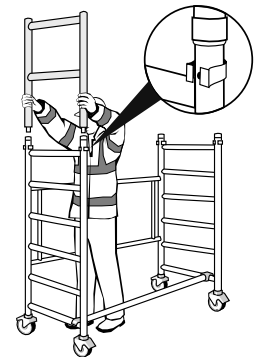

- 4** Fit a diagonal brace between the 5th rung of the base unit and the lower rung of a guardrail frame.

IMPORTANT: Always ensure braces are fully locked in position.

Fit a trapdoor platform on the 6th rungs of the base unit. Engage the windlocks, underneath the rungs, at both ends of the platform.

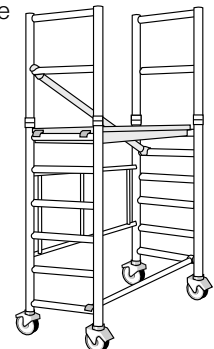

Assembly Procedure

5 If the tower is being used externally, attach one SP7 stabiliser (small) to each corner of the tower. Loosen the clamps and position around the uprights of the tower. Tighten the clamps hand tight. Refer to Stabiliser section for guidance on positioning stabilisers.



6 Climb the tower on the inside and from a protected position within the trapdoor, fit 4 horizontal braces as guardrails on the upper and lower rungs of the guardrail frames, on both sides of the platform. **IMPORTANT:** Always ensure braces are fully locked in position.



When horizontal braces are fitted as guardrails they should always be 0.5m and 1.0m above the platform surface.

NEVER stand on a platform until the Guardrail braces are in place.



If your risk assessment shows it is necessary, fit toe boards to the platform checking that there are no gaps and that the trapdoor opens and closes correctly. The tower structure is now complete at 1.7m platform height.

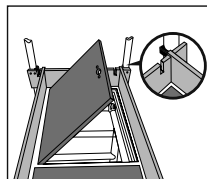

See section FITTING TOEBOARDS

Assembly Procedure

STAGE 4

COMPOSITE CODE 380637
MAXIMUM PLATFORM HEIGHT 3.7M
MAXIMUM WORKING HEIGHT 5.7M

- 1 BASE PACK
- 1 ADJUSTABLE LEG PACK (required if ground is uneven or sloping)
- 1 EXTENSION PACK
- 1 GUARDRAIL PACK (2 RUNG)
- 2 SP7 STABILISER (SMALL) PACKS (2 stabilisers per pack)

Follow Stage 1 - Step 1 - Setting Up the Base Unit

If the ground is uneven or sloping you will need to fit adjustable legs. See Fitting Adjustable Legs.

2 Fit a horizontal brace between the bottom rungs on the front face of the base unit. **IMPORTANT:** Always ensure braces are fully locked in position.

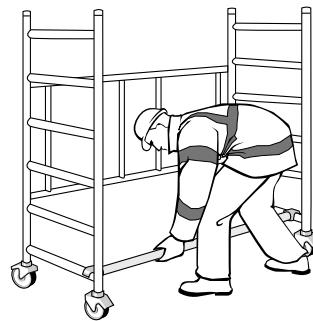

Assembly Procedure

3 Fit the 4 spring interlock clips supplied with the Extension Pack. Expand the clips over the top of the base unit uprights and then slide down to engage the pin on the clip into hole in the upright.

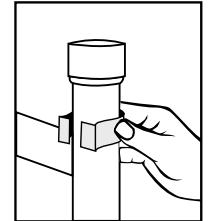
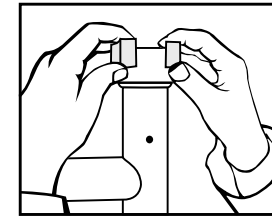

Fit an 8 rung Extension Frame at each end of the base unit. Ensure the 4 frame interlock clips are engaged

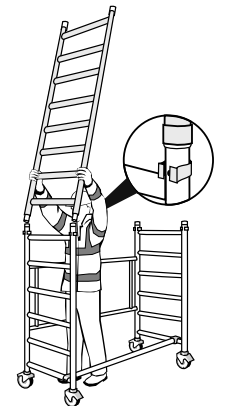

4 Fit a diagonal brace between the 4th and 7th rungs of the tower. **IMPORTANT:** Always ensure braces are fully locked in position. Fit another in the opposite direction between the 7th and 10th rungs, on the other side of the tower. Always ensure braces are fully locked and that braces connect lower frames with the opposite and upper frames.

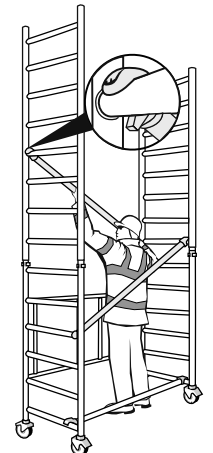

Assembly Procedure

5 Attach a SP7 stabiliser (small) to each corner of the tower. Loosen the clamps and position around the uprights of the tower. Tighten the clamps hand tight. Refer to Stabiliser section for guidance on positioning stabilisers.

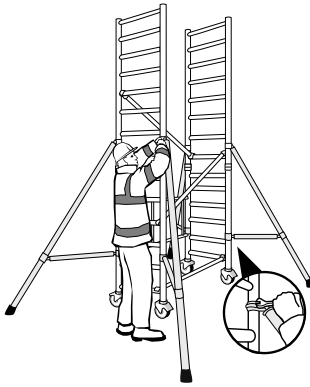

6 Position a trapdoor platform on the 8th rungs of the tower. Engage the windlocks, underneath the rungs, at both ends of the platform.



7 Climb the tower on the inside and from a protected position within the trapdoor, fit 4 horizontal braces as guardrails, 2 and 4 rungs above the platform, on both sides of the tower.



IMPORTANT: Always ensure braces are fully locked in position.

When horizontal braces are fitted as guardrails they should always be 0.5m and 1.0m above the platform surface. NEVER stand on a platform until the Guardrail braces are in place.

Assembly Procedure

8 Fit a third diagonal brace. The diagonal bracing should follow a zig-zag pattern on alternate sides of the tower. Fit the 4 spring interlock clips supplied with the Guardrail Pack. Fit a two rung guardrail frame at each end of the base unit. Ensure the 4 frame interlock clips are engaged

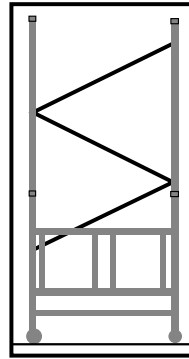

9 Fit a fourth diagonal brace between the lower rung of the 2 rung Guardrail frame and the 8 rung extension frame.



10 The platform must now be repositioned onto the 6th rung of the tower as follows: Unlatch the 4 guardrail brace hooks furthest from the trapdoor but leave the braces in position. From the protected position trapdoor position, unlatch the 4 remaining brace hooks and remove the 4 guardrail braces.



Assembly Procedure

Descend the tower. The platform should now be repositioned in the tower by moving it from 8th rungs to the 6th rungs (the top rungs of the base frame).

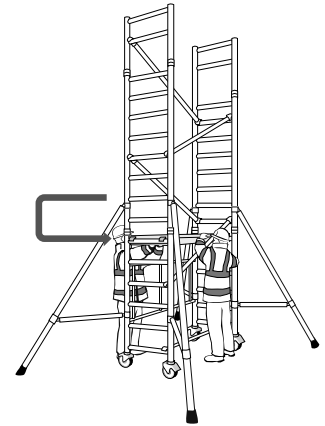

11 Engage the windlocks, underneath the rungs, at both ends of the platform. Climb the tower and from the protected trapdoor position refit the 4 guardrail braces, 2 and 4 rungs above the platform, on both sides of the tower.



NEVER stand on a platform until the Guardrail braces are in place.

12 Position a trapdoor platform on the 14th rungs of the tower (the top rungs of the 8 rung extension frames). Engage the windlocks, underneath the rungs, at both ends of the platform.

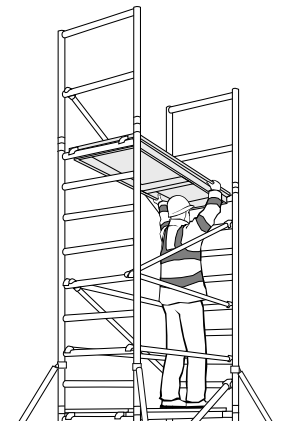

Assembly Procedure

13 Climb the tower on the inside and from a protected position within the trapdoor, fit 4 horizontal braces as guardrails on the upper and lower rungs of the guardrail frames, on both sides of the platform.

NEVER stand on a platform until the Guardrail braces are in place.

Fit the toe boards checking there are no gaps and that the trapdoor opens and closes correctly. See FITTING TOEBOARDS

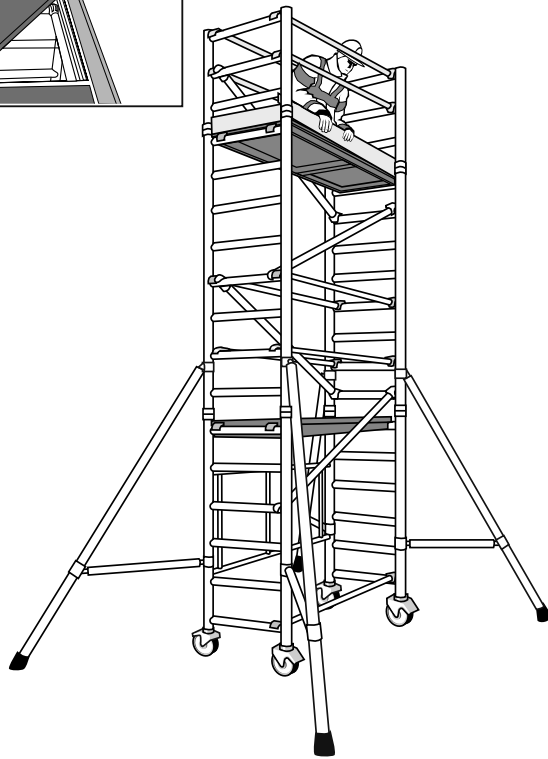
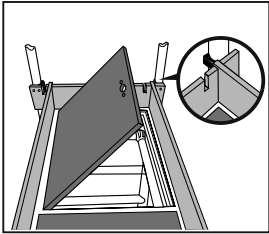

The tower is now complete at a platform height of 3.7m.

Assembly Procedure

STAGE 5

COMPOSITE CODE 380658
MAXIMUM PLATFORM HEIGHT 5.8M
MAXIMUM WORKING HEIGHT 7.8M

- **1 BASE PACK**
- **1 ADJUSTABLE LEG PACK**
(required if ground is uneven or sloping)
- **2 EXTENSION PACKS**
- **1 GUARDRAIL PACK (2 RUNG)**
- **2 SP10 STABILISER (MEDIUM) PACKS**
(2 stabilisers per pack)

Follow Stage 1 - Step 1 - Setting Up the Base Unit

If the ground is uneven or sloping you will need to fit adjustable legs. See Fitting Adjustable Legs.

Follow Stage 4 - steps 2, 3, 4, 5, 6 and 7

8 Fit a third diagonal brace. The diagonal bracing should follow a zigzag pattern on alternate sides of the tower.

Fit the 4 spring interlock clips supplied with 2nd Extension Pack to the uprights of the 8 Rung Extension frames.

Expand the clips over the top of the base unit uprights and then slide down to engage the pin on the clip into hole in the upright.

Fit an 8 rung Extension frame at each end of the base unit.

Ensure the 4 frame interlock clips are engaged.



Assembly Procedure

9 Fit a fourth diagonal continuing the zig-zag pattern on alternate sides of the tower. Position another trapdoor platform on the 16th rungs of the tower (the 2nd rungs of the upper extension frame). Engage the windlocks, underneath the rungs, at both ends of the platform.

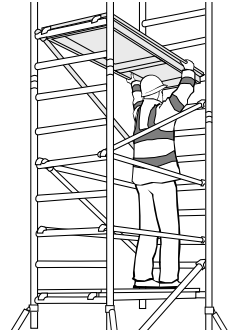

10 Climb the tower and from the protected trapdoor position fit a fifth diagonal brace following the zigzag pattern on alternate sides of the tower but positioning the brace 1 rung above the platform as shown.

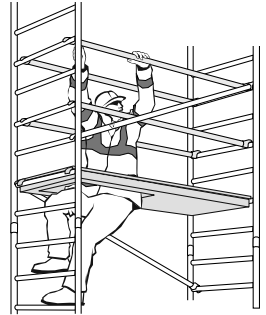

11 Fit 4 horizontal braces as guardrails, 2 and 4 rungs above the platform, on both sides of the tower. NEVER stand on a platform until the Guardrail braces are in place.

Fit the 4 spring interlock clips supplied with the Guardrail Pack. Expand the clips over the top of the 8 rung Extension Frame uprights and then slide down to engage the pin on the clip into hole in the upright.

Fit a 2 rung Guardrail frame at each end of the tower. Ensure the 4 frame interlock clips are engaged.

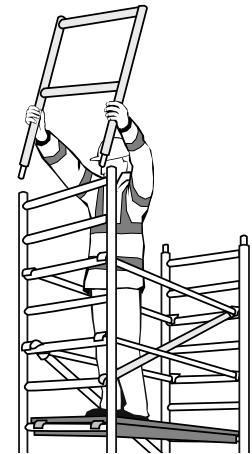

Assembly Procedure

12 Fit a sixth diagonal brace continuing the zig-zag pattern on alternate sides of the tower but position the lower hook 2 rungs above the platform as shown.

Fit a seventh diagonal brace on the opposite side of the tower between the lower rung of the 2 rung Guardrail frame and the 8 rung extension frame as shown.

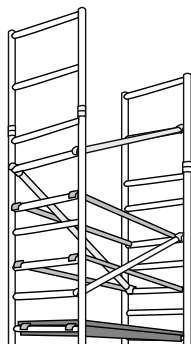

13 Both platforms must now be repositioned in the tower as follows:

On the upper platform, unlatch the 4 guardrail brace hooks furthest from the trapdoor but leave the braces in position.

From the protected position trapdoor position, unlatch the 4 remaining brace hooks and remove the 4 guardrail braces. Descend the tower to the platform below.

Remove the upper platform from the tower.

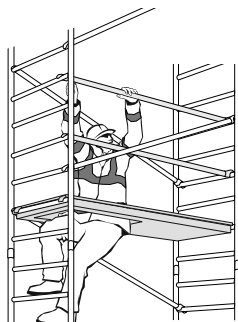

14 Repeat the previous steps to remove the 4 guardrail braces from the remaining platform and then descend from the tower. The remaining platform should now be repositioned in the tower by moving it from 8th rungs to the 6th rungs (the top rungs of the base frame).

Engage the windlocks, underneath the rungs, at both ends of the platform.

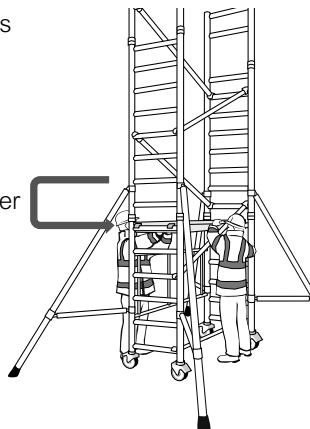

Assembly Procedure

15 Climb the tower on the inside and from a protected position within the trapdoor, fit 4 horizontal braces as guardrails, 2 and 4 rungs above the platform, on both sides of the tower. NEVER stand on a platform until the Guardrail braces are in place.

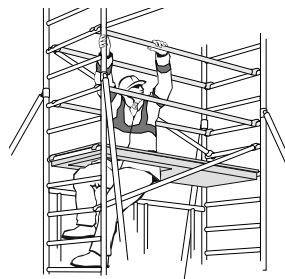

16 Reposition a trapdoor platform on the 14th rungs of the tower (the top rungs of the lower 8 rung Extension frame.)

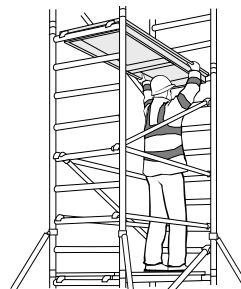

17 Climb the tower and from the protected trapdoor position refit the 4 guardrail braces, 2 and 4 rungs above the platform, on both sides of the tower. NEVER stand on a platform until the Guardrail braces are in place.

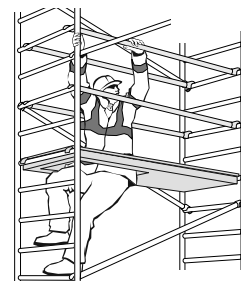

18 Position a trapdoor platform on the 22nd rungs of the tower (the top rungs of the upper 8 rung extension frame). Engage the windlocks, underneath the rungs, at both ends of the platform.

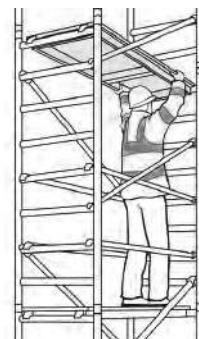

Assembly Procedure

19 Climb the tower and from the protected trapdoor position fit 4 guardrail braces, 2 and 4 rungs above the platform, on both sides of the tower.

NEVER stand on a platform until the Guardrail braces are in place. Fit the toe boards checking there are no gaps and that the trapdoor opens and closes correctly. See FITTING TOEBOARDS

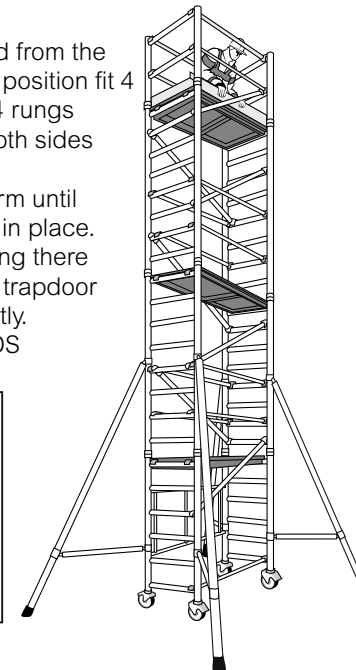
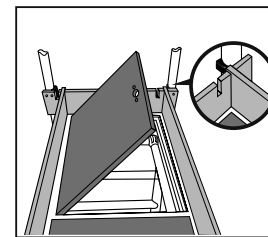

The tower is now complete at a platform height of 5.7m.

Dismantling Procedure

Dismantling the tower is the reverse procedure to assembly. ALWAYS reposition platforms and guardrails as shown.

When removing or repositioning Guardrail Braces always proceed as follows:

Unlatch the 4 guardrail brace hooks furthest from the trapdoor but leave the braces in position. From the protected position trapdoor position, unlatch the 4 remaining brace hooks and remove the 4 guardrail braces and then descend

NEVER stand on a platform without Guardrail braces.

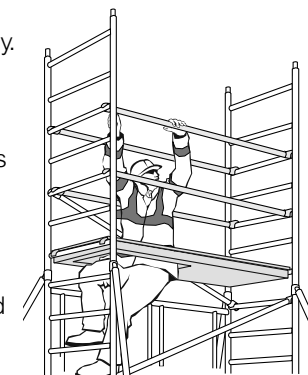

Assembly Procedure



FITTING TOEBOARDS

Start with the End Boards which have red plastic clips. There are two slots depending on which side you position the diagonal brace. Clip into correct slots, as shown, ensuring that no large objects can fall through and that the trap door can open with ease.

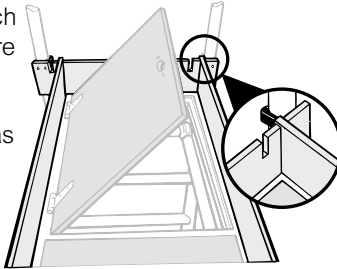

STABILISER

Attach one stabiliser to each corner of tower at approx. 45 degrees. The bottom clamp should be fitted as low as possible, refer to the diagram below. Ensure that all 4 rubber feet are in contact with the ground and that the clamps are secured. Position stabilisers as shown in diagrams.

When using the SP10 stabilisers (medium), always extend the telescopic legs to their maximum position and lock into position with the interlock clip.

When moving tower lock each telescopic leg just clear of the ground, unlock castors ensuring area is firm and clear of all obstructions both on the ground and above. After moving check all castors are firmly on the ground and locked, and that the tower is vertical. Re-position stabilisers as above.

SP7 STABILISER (SMALL)

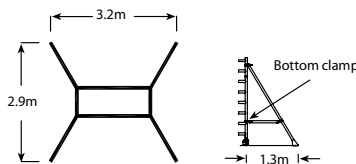

SP10 STABILISER (MEDIUM)

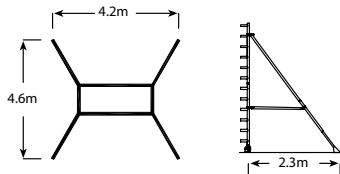

For further information about this product or any other products and services, please contact :

Youngman Group Ltd

The Causeway, Maldon,
Essex, CM9 4LJ,
United Kingdom

t +44 (0)1621 745900

f +44 (0)1621 859845

e youngman-sales@wernerco.com

Youngman are members of:



youngmangroup.com

Part No: 000633 Date: July 2015