

ENGLISH
DEUTSCHE
ESPAÑOL
FRANÇAIS
ITALIANO

UNI-PROP[®]

HYDRAULIC ASSEMBLY

Model Number: UP-HA-17-A

USER INSTRUCTIONS

INCLUDING OPERATION WITH UNI-PROP ACROW



PDF DOWNLOAD AT: UNI-PROP.COM



UNI-PROP[®]

HYDRAULIC ASSEMBLY

Model Number: UP-HA-17-A

CONTENTS

Important Safety Information	4
Product Features	5
Operation	6
Function & Guidance	7
General Maintenance	8
Technical Specification	9
Declaration of Conformity	10
UK Warranty	11
Operation with Uni-Prop Acrow	13
Risk Assessment	14
Uni-Prop Acrow Features	15
Uni-Prop Acrow Installation	16-17
Uni-Prop Acrow Removal	18-19
Safe Working Loads - Hydraulic Operation	20
Safe Working Loads - Mechanical Operation	21
Troubleshooting	22
General Maintenance	23

All images and diagrams in this document are for demonstration purposes only. Actual product appearance may differ from what is shown.

IMPORTANT SAFETY INFORMATION



Take note of safety alert symbols, which highlight potential hazards.

The above warning depicts a hazardous situation which, if not avoided, could lead to physical harm or damage to equipment or property.

PRIOR TO USE, PLEASE READ THE USER INSTRUCTIONS AND ENSURE THAT A RISK ASSESSMENT HAS BEEN CARRIED OUT.

THE CAPACITY OF THE HYDRAULIC ASSEMBLY IS DE-RATED TO 2T (2000kg) FOR OPERATION WITH UNI-PROP ACROW. NEVER EXCEED SAFE WORKING LOADS.

IN THE CONSIDERATION OF SAFETY PLEASE ENSURE THAT AS SOON AS THE HYDRAULIC OPERATION HAS BEEN COMPLETED, THE MECHANICAL COLLAR AND PIN FUNCTION MUST BE ENGAGED IMMEDIATELY TO AVOID THE POTENTIAL FOR ACCIDENT/DAMAGE.

ONLY THE UNI-PROP HYDRAULIC ASSEMBLY CAN BE USED WITH THE RANGE OF UNI-PROP ACROWS.

PLEASE NOTE: Pay special attention to all instructions written in **RED** regarding the installation and removal of Uni-Prop Acrow.

These instructions do not cover all possible conditions and situations of use and deployment that may occur. The health and safety rules and procedures in force where people are at work may require the person responsible for this equipment to carry out a specific risk assessment to comply with any applicable legislation.

Disclaimer: Uni-Prop International and its appointed resellers and distributors cannot be held responsible for any damage or injury that may occur as a result of improper use of Uni-Prop products.

PRODUCT FEATURES

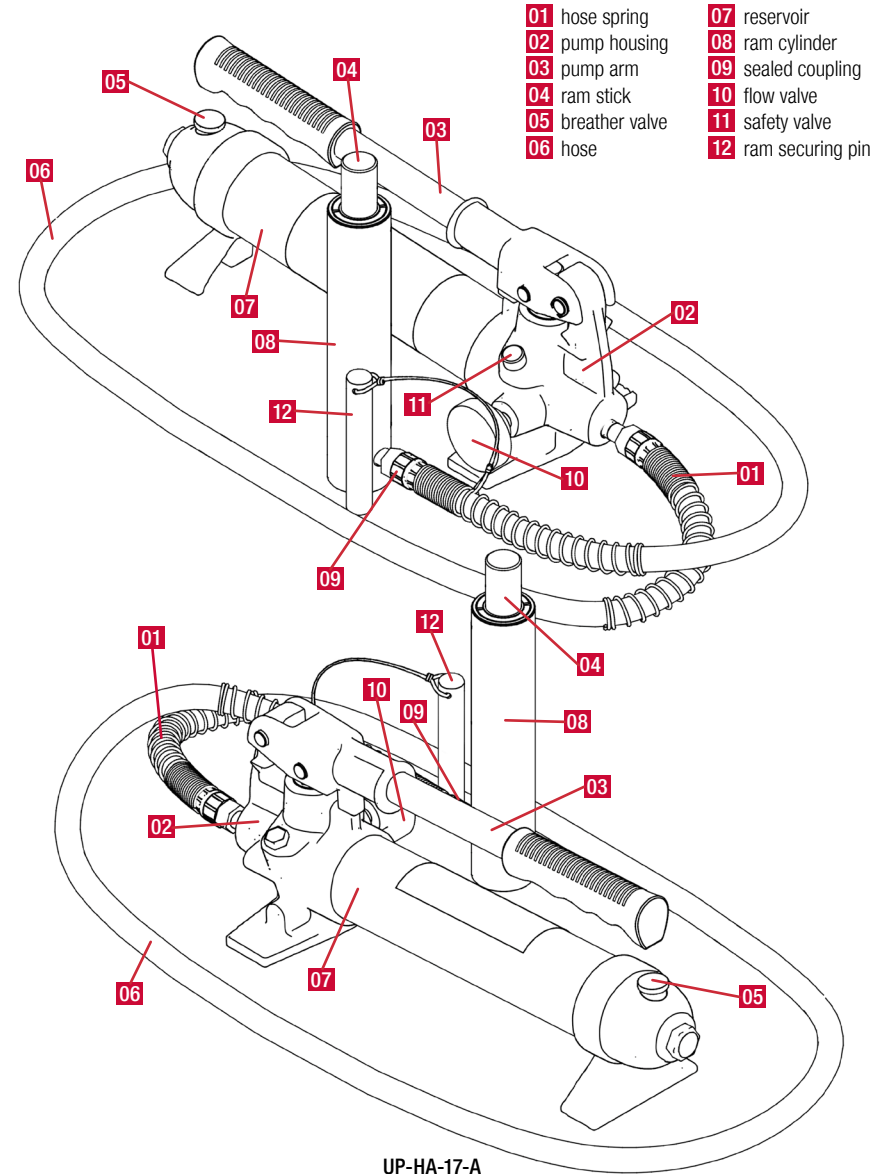

OPERATION



Remove the Hydraulic Assembly from the HDPE storage case.

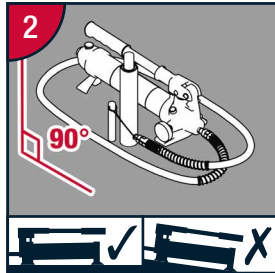

Ensure the Hydraulic Assembly is placed in a horizontal position or it will not function properly.

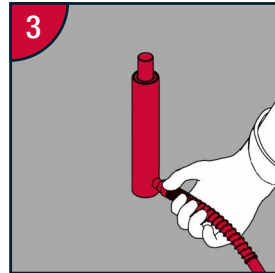

Hydraulic Assembly can be used vertically.

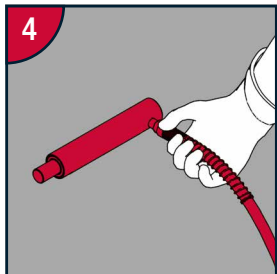

Hydraulic Assembly can be used horizontally.

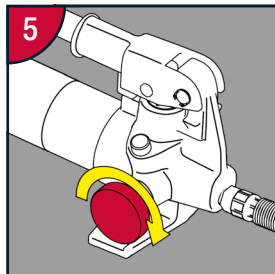

To engage, ensure flow valve is fully closed (turn clockwise to close).

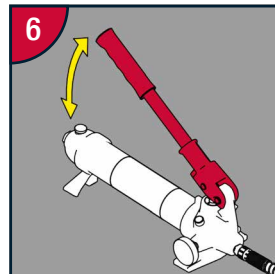

Pump the handle to raise ram stick.

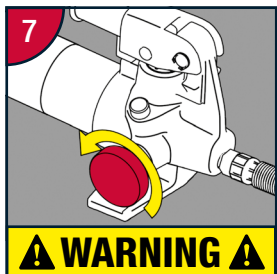

To release ram stick, open flow valve. **Never rotate more than one full turn anti-clockwise.**

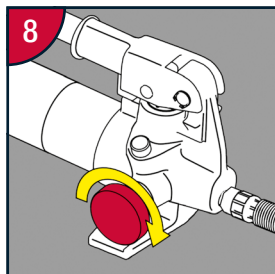

When making ready for storage, ensure flow valve is in the closed position.



Replace the Hydraulic Assembly in its case.

FUNCTION & GUIDANCE

THE HYDRAULIC ASSEMBLY IS SUPPLIED AS A SEALED UNIT FOR EXCLUSIVE USE WITH THE UNI-PROP ACROW.

Function: With flow valve closed, an upward stroke of the pump handle draws oil from the reservoir into the ram cavity. Hydraulic pressure holds the flow valve closed, which keeps the oil in the ram cavity. A downward stroke of the pump handle releases oil into the cylinder, which forces out the ram stick. When the ram stick reaches maximum extension, the surplus oil returns into the reservoir to prevent an over extended ram stroke and possible damage to the unit. Opening the flow valve releases the hydraulic pressure and the oil returns to the reservoir, which results in lowering the ram.

Environmental precautions: In the unlikely event of excessive oil seepage, contain the spillage with sand or earth. Prevent any spillage or runoff entering drains, sewers or watercourses. The product is insoluble in water and will spread on the water surface.

Disposal methods: Dispose under European Waste Catalogue (EWC) 13 01 13* (other hydraulic oils). The hydraulic assembly must be disposed of as hazardous waste; dispose via a licensed waste contractor.



THE FLOW VALVE MUST NEVER BE OVER-ROTATED WHEN DISENGAGING THE HYDRAULIC ASSEMBLY. A MAXIMUM OF ONE FULL TURN ANTI-CLOCKWISE WILL ALWAYS BE SUFFICIENT. IF OVER-ROTATED THE FLOW VALVE MAY BECOME DETACHED AND COMPROMISE THE PERFORMANCE AND WARRANTY.

GENERAL MAINTENANCE

CARE MUST BE TAKEN TO KEEP THE OPERATION OF THE HYDRAULIC ASSEMBLY IN GOOD WORKING ORDER.

The Hydraulic Assembly must be inspected annually by a qualified person.

This inspection should be performed yearly on or before the anniversary of the original date of purchase.

Do not fill or bleed the hydraulic fluid.

This is a sealed unit and any such action would be hazardous and invalidate the warranty.

This is a sealed unit and requires no air purging or adjustment. Please note: An initial small seepage of oil is perfectly normal but if this persists please contact your supplier.

Keep all surfaces of the Hydraulic Assembly free of dirt and grease. Use only a mild detergent and damp cloth when cleaning.

Do not use a flammable or combustible solvent to clean the Hydraulic Assembly.

Store the Hydraulic Assembly in the HDPE case and ensure the flow valve is closed (turned clockwise).

A coating of light lubricating oil to pivot points, axles and hinges will help prevent rust and ensure the continued good performance of the assembly.

Periodically check all moving parts for signs of rust or corrosion. Clean as needed and wipe with a soft non-abrasive cloth.

When the assembly is not in use always store with the ram fully retracted and never expose to rain.

TECHNICAL SPECIFICATION

THE HYDRAULIC ASSEMBLY IS SUPPLIED AS A SEALED UNIT COMPRISING: RAM CYLINDER, HOSE, PUMP UNIT AND RAM SECURING PIN.

Capacity	De-Rated to 2T (2000kgs)
Max. Working Pressure	33MPa
Min. Height	235mm
Max. Height	355mm
Stroke Length	120mm
Oil Filled	300ml
Oil Type	15# refrigerant oil
Operating Temp range	-20°C to +50°C
Hose	2S/N, 1.75m
Package Size	550 × 310 × 210mm
Gross Weight	11kgs
Net Weight	7.6kgs

THE SAFETY VALVE ADJUSTS UNDER GRADUALLY INCREASING PRESSURE AND IS SET TO A MAXIMUM CAPACITY OF 2T (2000KGS) WHEN USED WITH UNI-PROP ACROW.



THE HYDRAULIC ASSEMBLY MUST BE INSPECTED ANNUALLY BY A QUALIFIED PERSON.

DECLARATION OF CONFORMITY

THIS HYDRAULIC ASSEMBLY HAS BEEN TESTED ACCORDING TO ALL RELEVANT CURRENT CE GUIDELINES. MACHINE DIRECTIVE 2006/42/EC.

EN 1494: 2000+A1:2008

Mobile or moveable jacks and associated lifting equipment.

EN ISO 12100: 2010

Safety of machinery – General principles for design – Risk assessment and risk reduction.



UK WARRANTY

Limited Warranty

Uni-Prop International Ltd. (“We” or “Us”) warrants to the original purchaser only (“You” or “Your”) that the Uni-Prop Hydraulic Assembly product purchased will be free from material defects in both materials and workmanship, normal wear and tear excepted, for a period of one year from date of purchase. The foregoing warranty is valid only if the installation and use of the product is strictly in accordance with product instructions. There are no other warranties, express or implied, including the warranty of merchantability or fitness for a particular purpose. If the product does not comply with this limited warranty, Your sole and exclusive remedy is that We will, at our sole option and within a commercially reasonable time, either replace the product without charge to You or refund the purchase price (less shipping). This limited warranty is not transferable.

Warranty Updates

We reserve the right to change our warranty terms at any time.

Limitations on the Warranty

This limited warranty does not cover: (a) normal wear and tear; (b) damage through abuse, neglect, misuse, or as a result of any accident or in any other manner; (c) damage from misapplication, overloading, or improper installation; (d) improper maintenance and repair; and (e) product alteration in any manner by anyone other than Us, with the sole exception of alterations made pursuant to product instructions and in a workmanlike manner.

Obligations of Purchaser

You must retain Your product purchase receipt to verify date of purchase and that You are the original purchaser. To make a warranty claim, contact your supplier, identify the product by make and model number, and follow the claim instructions that will be provided. The product and the purchase receipt must be provided to Us in order to process Your warranty claim. Any returned product that is replaced or refunded by Us becomes our property. You will be responsible for return shipping costs or costs related to Your return visit to a retail store.

Remedy Limits

Product replacement or a refund of the purchase price is Your sole remedy under this limited warranty or any other warranty related to the product. We shall not be liable for: service or labour charges or damage incurred to Your trailer or vehicle in removing or replacing the product; any damages, including, without limitation, damages to tangible personal property or personal injury, related to Your improper use, installation, or maintenance of the product; or any indirect, incidental or consequential damages of any kind for any reason.

Assumption of Risk

You acknowledge and agree that any use of the product for any purpose other than the specified use(s) stated in the product instructions is at Your own risk.

Ownership of Trademarks and Copyright

All trademarks/names featured in this document or at www.uni-prop.com are owned by the respective trademark owners, © 2020 Uni-Prop® International Ltd. All rights reserved.

Your Legal Rights

You (as the consumer) have legal (statutory) rights under applicable national laws relating to the sale of consumer products. These rights vary from region to region. This limited warranty does not affect the statutory rights you may have nor those rights that cannot be excluded or limited, nor rights against the person from whom you purchased the product. You may assert any rights you have at your sole discretion

Governing Law

Unless some other law is agreed in writing, this limited warranty policy is governed by English law. If there is a dispute, it will only be dealt with in the courts of England or of the country within the United Kingdom in which your main residence is situated.



HYDRAULIC ASSEMBLY

USER INSTRUCTIONS

OPERATION WITH UNI-PROP ACROW



RISK ASSESSMENT

PRIOR TO USE, ENSURE A RISK ASSESSMENT HAS BEEN CARRIED OUT AND THE SAFE WORKING LOADS ARE CALCULATED CORRECTLY.

- For safe deployment always carefully plan the use of Uni-Prop Acrow.
- Uni-Prop Acrow should only be used by persons who have the necessary training.
- It is essential to wear the correct PPE (Personal Protective Equipment) identified in the risk assessment.
- Uni-Prop Acrow must never be used by anyone under the influence of drugs or alcohol.
- Uni-Prop Acrow is designed for operation by an able bodied adult. Anyone with temporary or permanent disability should seek expert advice before using them.
- The Uni-Prop Acrow model selected must be fit for the purpose. Ensure the load capacities/ extensions are appropriate for the application (p20-21).
- Check top pin and wire are attached to Uni-Prop Acrow.
- Check ram securing pin and wire are attached to the Hydraulic Assembly.
- Always operate the Hydraulic Assembly from a safe working position.
- Check the Uni-Prop Acrow is in good working order and free of obstruction in ram access chamber.
- It is recommended that the use of Uni-Prop Acrow is a two person operation.

AS SOON AS THE HYDRAULIC OPERATION HAS BEEN COMPLETED, THE MECHANICAL COLLAR AND PIN FUNCTION MUST BE ENGAGED IMMEDIATELY TO AVOID THE POTENTIAL FOR ACCIDENT/DAMAGE.



Inner tube holes must align with the threaded slot on outer tube prior to engaging the Hydraulic Assembly (p16 fig.08). If the holes are not aligned then the hydraulic pressure will need to be disengaged to enable the inner tube to turn to reveal the holes in the threaded slot section. In this eventuality, it is recommended that an additional Uni-Prop is deployed by its mechanical function to prevent any risk of injury or damage during the process of disengaging the hydraulic assembly.

UNI-PROP ACROW FEATURES

- | | |
|----------------------------|-----------------------|
| 01 top plate | 07 collar & handle |
| 02 inner tube | 08 outer tube |
| 03 safety stop (Maxi only) | 09 ram movement slot |
| 04 threaded section | 10 ram locator boss |
| 05 threaded slot | 11 ram access chamber |
| 06 top pin & wire | 12 baseplate |

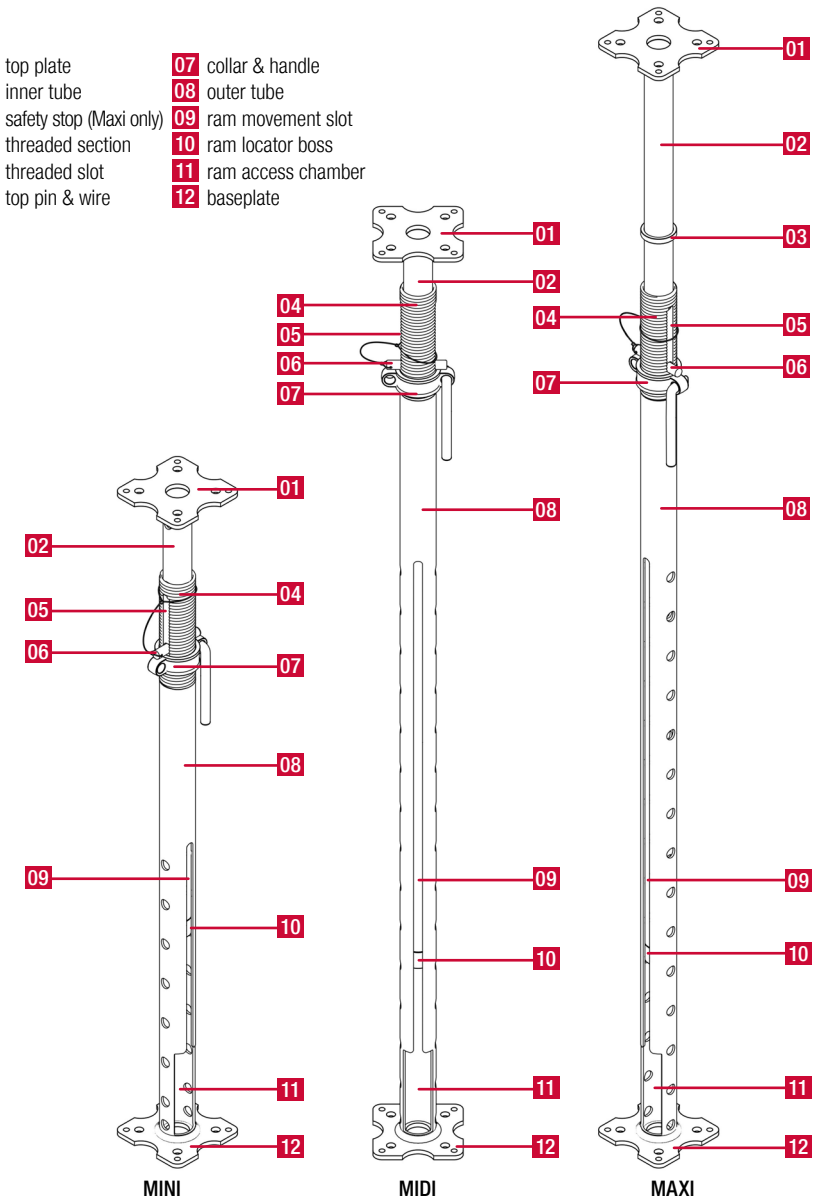

UNI-PROP ACROW INSTALLATION

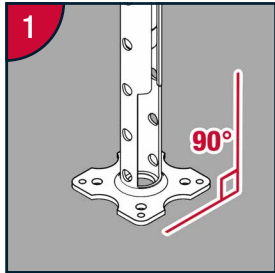

For vertical installation place plumb on a firm flat level surface.

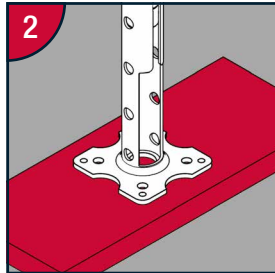

If necessary use a sole board to distribute load.

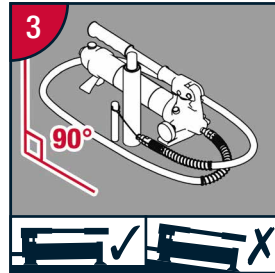

Place Hydraulic Assembly on level ground in horizontal position.

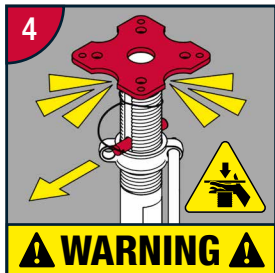

Remove top pin. **Inner tube fully retracts. Be aware of trap/crush injuries.**

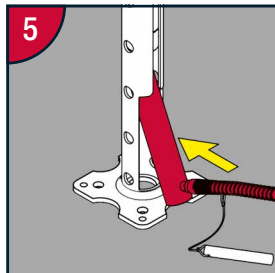

Insert ram into ram access chamber.

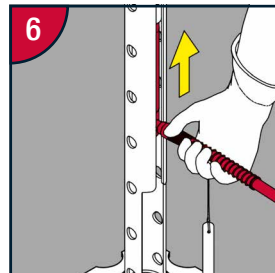

Lift hose to raise ram and inner tube until top plate is close to object surface.

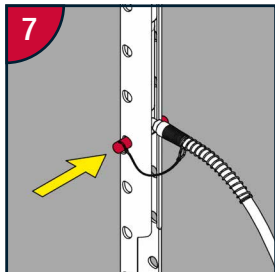

Insert ram securing pin through first available hole **directly beneath** the ram.

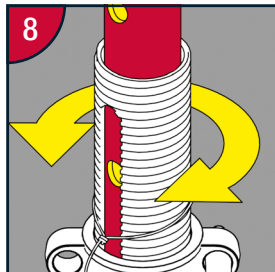

Prior to engaging the pump align holes of inner tube with slot in threaded collar section.

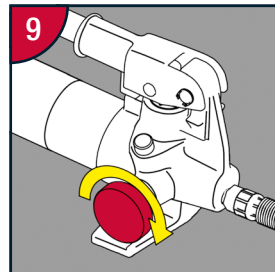

Check pump is horizontal and flow valve is fully closed (turn clockwise to close).

UNI-PROP ACROW INSTALLATION

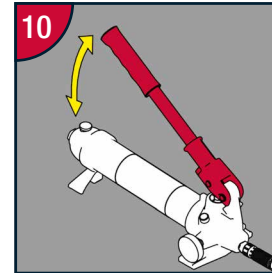

Pump the handle to raise the top plate until the required position is achieved.

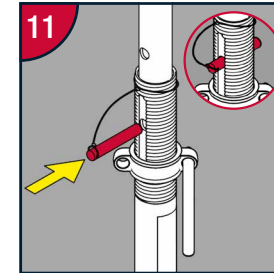

Insert top pin through the available hole in the threaded section above the collar.

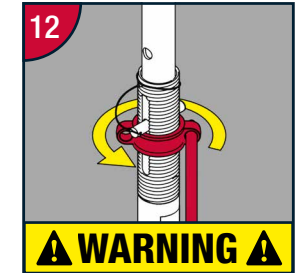

WARNING
Immediately turn collar until tight against top pin to fully secure the position.

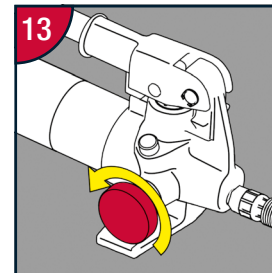

To release ram stick, open flow valve. **Never rotate more than one full turn anti-clockwise.**

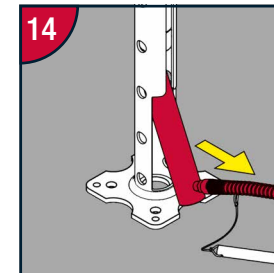

Whilst holding hose, take out ram securing pin then lower hose and remove ram.



Replace the Hydraulic Assembly in its case or re-use on another Uni-Prop Acrow.



DO NOT USE EXCESSIVE FORCE WHEN PUMPING.

DO NOT OVER-PUMP WHEN A SIGNIFICANT CHANGE IN RESISTANCE HAS RESULTED. THIS MAY COMPROMISE THE PERFORMANCE OF THE HYDRAULIC ASSEMBLY AND INVALIDATE THE WARRANTY.

WARNING

UNI-PROP ACROW REMOVAL

UNI-PROP ACROW REMOVAL

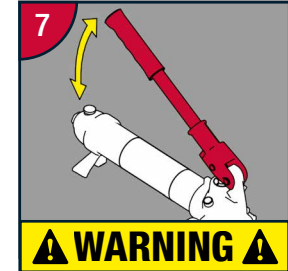

WARNING
PLEASE NOTE: THE HYDRAULIC ASSEMBLY WILL NEED TO BE RE-ENGAGED IF THE COLLAR DOES NOT FREELY UNWIND BY HAND.
WHEN NECESSARY, ENSURE THAT ONLY MINIMAL PRESSURE IS APPLIED TO FREE UP THE COLLAR.

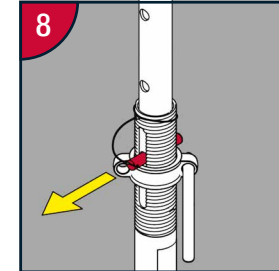

Pump the handle just enough to free up the collar. *Do not over-pump.*

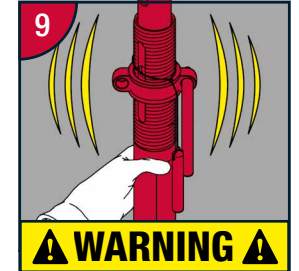

Remove the top pin.



Support outer tube to prevent topple.

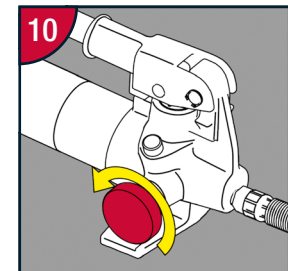

Open flow valve to allow ram stick to retract and inner tube to lower.

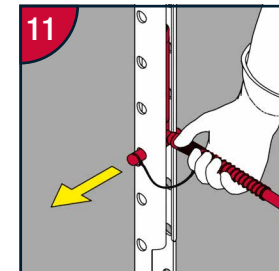

Whilst holding the hose, remove the ram securing pin.

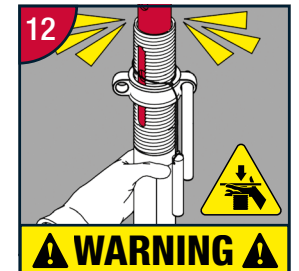

Continue to support outer tube and lower the hose. *Be aware of trap/crush injuries.*

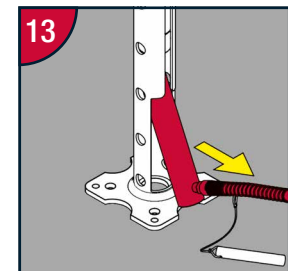

Continue to support outer tube and remove ram via ram access chamber.

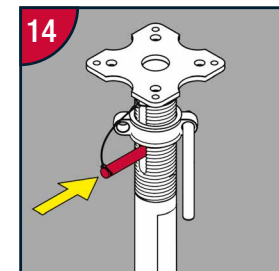

Replace top pin through available hole below collar and the removal is complete.



Replace the Hydraulic Assembly in its case or re-use on another Uni-Prop Acrow.

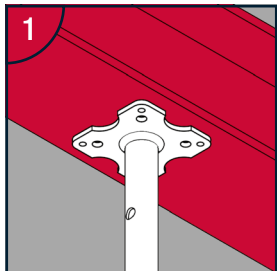

Ensure Uni-Prop Acrow can be safely removed.

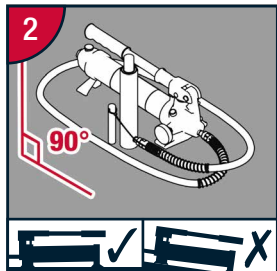

Place Hydraulic Assembly on ground in horizontal position.

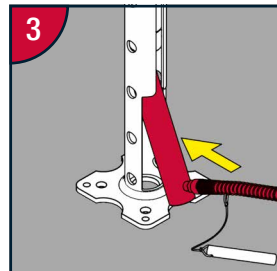

Insert ram into ram access chamber.

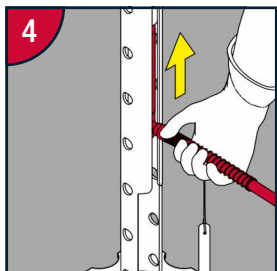

Lift hose to raise ram until ram is as near as possible to inner tube.

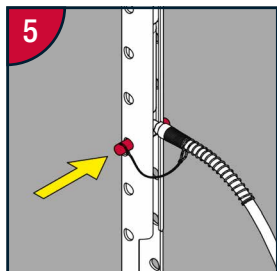

Insert ram securing pin through first available hole *directly beneath* the ram.

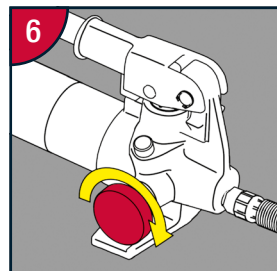

Check flow valve is in the fully closed position (turn clockwise to close).

SAFE WORKING LOADS - HYDRAULIC OPERATION

LOADED CONCENTRICALLY AND 1° MAX OUT OF PLUMB

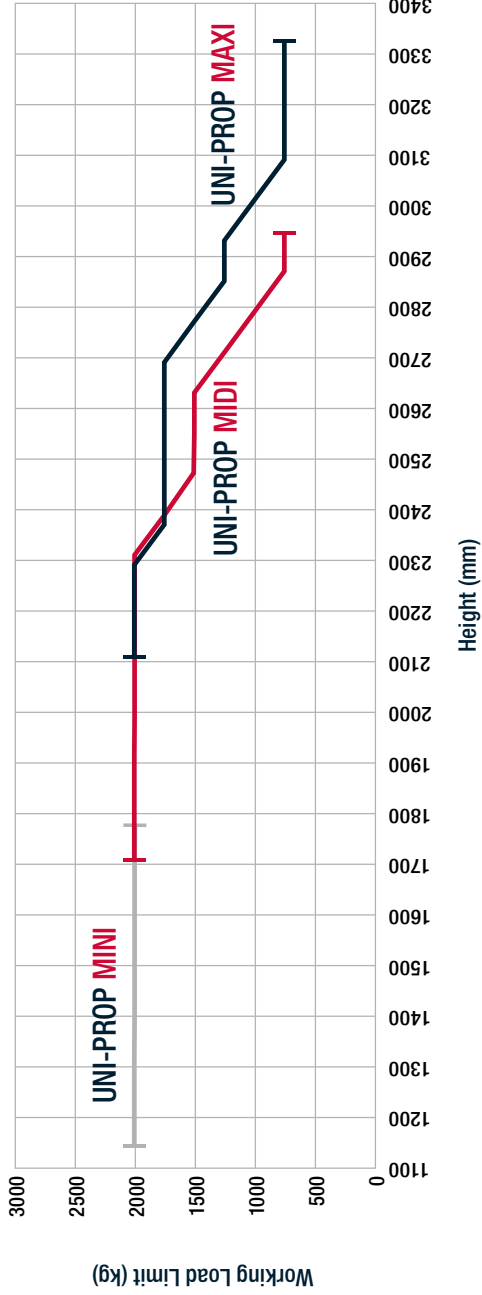

NEVER EXCEED SAFE WORKING LOADS

- i) Safe Working Loads have been derived from load testing to BS EN 1065.
- ii) Hydraulic Safe Working Loads are calculated to a minimum Factor of Safety of 2.5 to 1 on test results.
- iii) Convert kg to kN: 10kg = 0.09807kN. e.g. 100kg = 0.9807kN, 1000kg = 9.807kN, 5000kg = 49.04kN.

SAFE WORKING LOADS - MECHANICAL OPERATION

LOADED CONCENTRICALLY AND 1° MAX OUT OF PLUMB

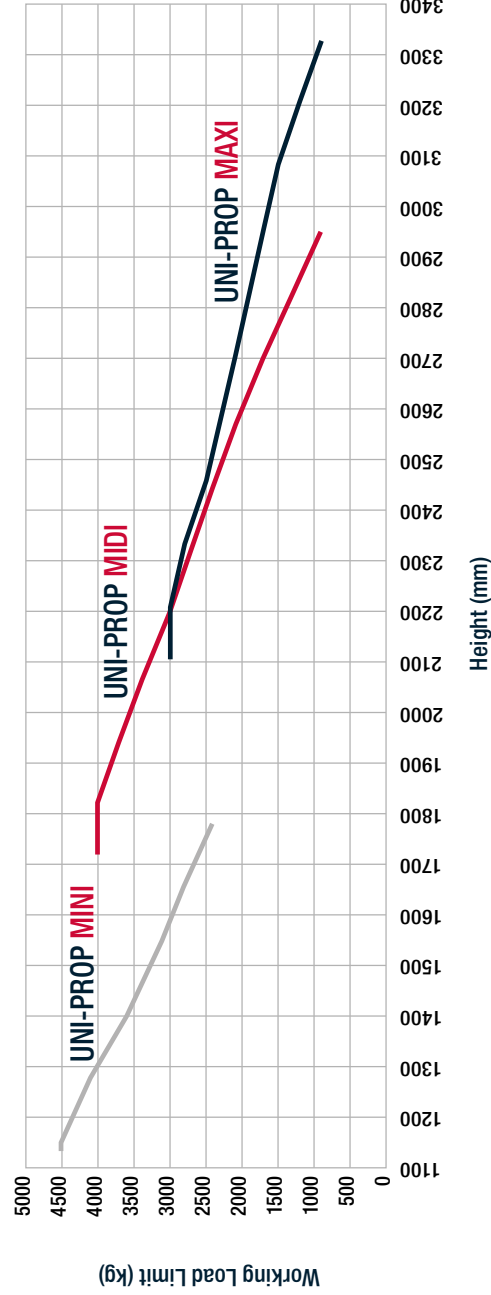

NEVER EXCEED SAFE WORKING LOADS

- i) Safe Working Loads have been derived from load testing to BS EN 1065.
- ii) Mechanical Safe Working Loads are calculated to a minimum Factor of Safety of 2 to 1 on test results.
- iii) Convert kg to kN: 10kg = 0.09807kN. e.g. 100kg = 0.9807kN, 1000kg = 9.807kN, 5000kg = 49.04kN.

TROUBLESHOOTING

Ram will not fit inside Ram Access Chamber.

- i) Check flow valve is in the open position (anti-clockwise, max one full turn) to enable complete retraction of ram stick.
- ii) Check chamber is free of obstruction.
- iii) Check there is no obstruction or debris within the ram locator boss at base of inner tube.

Ram stick will not extend.

- i) Check pump is on a horizontal surface.
- ii) Check flow valve is fully closed (clockwise).

Ram stick will not retract.

- i) Check pump is on a horizontal surface.
- ii) Check flow valve is in the open position (anti-clockwise, max one full turn).

Ram won't deliver power.

- i) Check Safe Working Loads have not been exceeded.

Cannot locate pin hole in threaded slot.

- i) Twist the inner tube to align holes with threaded slot.

Oil is leaking.

- i) A small seepage of oil during early use is perfectly normal.
- ii) If oil continues to leak, do not use the Hydraulic Assembly and contact your supplier.

Cannot remove Ram from Ram Access Chamber.

- i) Check flow valve is in the open position (anti-clockwise, max one full turn) to enable complete retraction of ram stick.
- ii) If this problem still persists, with the flow valve open, hold hose and tap ram stick up against bottom of inner tube so that the ram stick will fully retract.

The collar won't turn on the threaded section.

- i) Use WD-40 or equivalent to free up the collar.

IF YOU CONTINUE TO EXPERIENCE OPERATING ISSUES, PLEASE CONTACT YOUR SUPPLIER.

GENERAL MAINTENANCE

CARE MUST BE TAKEN TO KEEP THE UNI-PROP ACROW IN GOOD WORKING ORDER.

There is no regulation relating to the inspection of Uni-Prop Acrow but it is recommended to carry out a visual check regularly. This is to ensure all parts are clean and in good working order. Check top pin and wire is attached to Uni-Prop Acrow. Check ram securing pin is attached to the Hydraulic Assembly.

Prior to use with the Hydraulic Assembly, it is especially important to ensure the ram locator boss is free of debris or obstruction. This is located at the base of the inner tube and may be visually checked through the ram access chamber.

KEEP THESE USER INSTRUCTIONS

INSTRUCTIONS INCLUDE: SAFETY WARNINGS AND SAFEGUARDS; OPERATING, INSPECTION AND MAINTENANCE PROCEDURES.

For future reference, write the batch number including the month and year of purchase below (see nameplate on pump for details).

The user instructions should be kept in the HDPE storage case supplied.

When unpacking, make sure that the product is intact and undamaged. If any parts are missing or broken, please contact your supplier.

Environmental precautions: In the unlikely event of excessive oil seepage, contain the spillage with sand or earth. Prevent any spillage or runoff entering drains, sewers or watercourses. The product is insoluble in water and will spread on the water surface.

Disposal methods: Dispose under European Waste Catalogue (EWC) 13 01 13* (other hydraulic oils).

The hydraulic assembly must be disposed of as hazardous waste; dispose via a licensed waste contractor.

Batch Number	Date of Purchase	Supplier

No part of this document or any drawings contained herein may be reproduced in any shape or form without the written consent of Uni-Prop International Ltd.
© 2020 Uni-Prop International Ltd

Uni-Prop Hydraulic Assembly and Uni-Prop Acrow manufactured and distributed by:
Uni-Prop International Ltd, 19 Holywells Road, Ipswich, United Kingdom IP3 0DL

Telephone: 0800 2545 456 Email: support@uni-prop.com Web: uni-prop.com