



**MODEL 1824TK - 2324TK**  
**HYDRAULIC TRACK TRENCHER**  
**OPERATOR'S MANUAL**

**TRENCHER INTENDED USE**

This machine is designed for digging trenches in “normal” ground of reasonably soft dirt and stones up to 6” (15cm) in diameter. Ground with larger stones, high clay content, very hard packed, very dry, or in a frozen condition may be unsuitable for normal trenching. Consider using a backhoe or other heavier equipment for such conditions.

**TABLE OF CONTENTS**

LUBRICATION REQUIREMENTS .....	2
SAFETY MESSAGES .....	3
SAFETY INSTRUCTIONS OVERVIEW .....	4
BATTERY & ELECTRIC STARTER SAFETY INSTRUCTIONS .....	6
TRENCHER OPERATING INSTRUCTIONS .....	7
CONTROLS .....	7
ENGINE CONTROLS .....	8
ENGINE START UP PROCEDURE.....	9
GETTING STARTED.....	9
TRENCHING PROCEDURE .....	10
TRENCHING TIPS.....	10
SHUT DOWN PROCEDURE .....	10
JUMP STARTING ENGINE WITH ELECTRIC STARTER.....	11
GROUND TRANSPORT OF THE TRENCHER.....	12
EMERGENCY TOWING .....	13
ROAD TRANSPORT OF THE TRENCHER .....	14
OPERATOR PREPARATION .....	16
DETERMINE LOCATION OF UNDERGROUND UTILITIES.....	17
WORK SITE ASSESSMENT .....	18
CONTACT WITH UNDERGROUND UTILITIES .....	19
INDEX.....	20

# LUBRICATION REQUIREMENTS

Grease at the intervals indicated per the illustration of grease lubrication points. There is also a grease diagram decal on the machine.

Grease at the intervals indicated:

1. Track rear idlers weekly, or every 30 hours of use.
2. Track front rollers weekly, or every 30 hours of use.
3. Head pivot weekly, or every 30 hours of use.
4. Boom cylinder trunion (both sides) weekly, or every 30 hours of use.
5. Boom cylinder rod end every 12 hours of use.
6. Spindle daily, or every 6 hours of use.
7. Boom slider (both sides) weekly, or every 30 hours of use.
8. Dig chain roller daily, or every 6 hours of use.

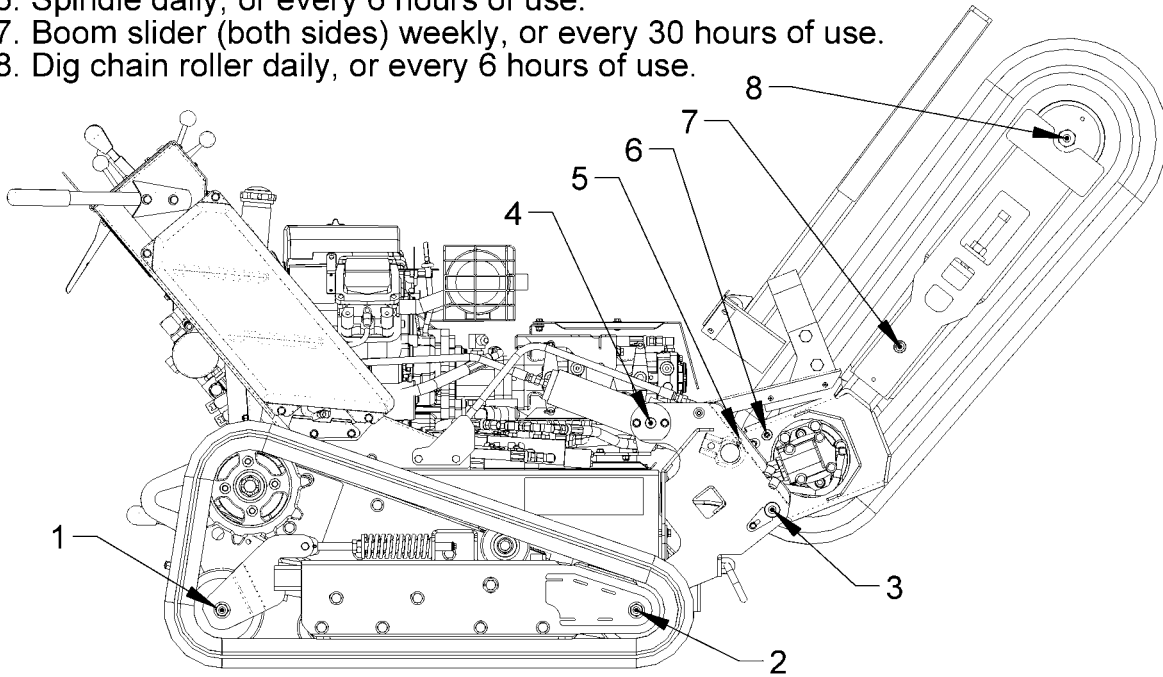

## SAFETY MESSAGES

General safety messages are listed in this Safety Messages section. Specific safety messages appear as appropriate in this manual where a potential hazard may occur if procedures or instructions are not followed correctly and completely.

### SAFETY SYMBOL



This is the international safety alert symbol. This symbol is used in combination with a signal word and written message to warn you of a potential for bodily injury or death.

A signal word "DANGER", "WARNING", or "CAUTION" is used with the safety alert symbol.



**DANGER:** Imminent hazards, that if not avoided, will result in serious personal injury or death.



**WARNING:** Potential hazards or unsafe practices, that if not avoided, could result in serious personal injury or death:



**CAUTION:** Potential hazards or unsafe practices, that if not avoided, could result in minor personal injury, product damage, or property damage.

Safety decals with a signal word "DANGER", "WARNING", or "CAUTION" are affixed to the trencher near specific hazards.

Read this manual and study ALL decals on the trencher before operating the trencher.

# SAFETY INSTRUCTIONS OVERVIEW

READ SAFETY AND OPERATING INSTRUCTIONS BEFORE OPERATING!

USE COMMON SENSE AND PLENTY OF IT!

The CLUTCH LEVER on the left handlebar is for the operator's protection. All motion stops when the lever is released.

**DO NOT TAPE THE CLUTCH LEVER UP or otherwise by-pass this safety feature.**

Call before you dig. If you do not call, you may cause an accident; suffer injuries or death; cause interruption of services; damage the environment; and/or incur project delays. Expect to be held liable for any damages caused, if you fail to call.

 **DANGER:** Buried electric cables or gas lines can cause serious injury or death if struck with dig chain. Always determine location of utilities before trenching.

 **WARNING:** Fiber optic cables convey laser light that can injure your eyesight.

STAY CLEAR of moving parts on the trencher.

 **DANGER:** Digging chain, auger and other moving parts can cut off arms, legs, or fingers. Contact with the digging chain or auger while in operation will cause serious injury or even death.



Wear safety goggles and a hard hat while operating or observing!

 **WARNING:** The dig chain may throw stones and debris.

Wear adequate hearing protection while operating or observing.

 **WARNING:** Exposure to loud noise is cumulative and may permanently damage your hearing.



Wear safety boots and gloves. Wear close-fitting clothing. Contain long hair. Do not wear jewelry. Wear reflective clothing if working near traffic.

Only operate outdoors and avoid breathing engine exhaust and fumes.

 **WARNING:** Engine exhaust contains carbon monoxide gas that is toxic. Breathing it can cause unconsciousness and death.

Adequate lighting is required, daylight or artificial, for safe operation of the trencher.

Allow adequate side and overhead clearances between trencher and buildings, fences, and trees.

 **WARNING:** If the dig chain contacts an object the digging chain can climb upward quickly and tip the trencher toward the operator. Serious injury or death will result by operator contact with the moving chain. The digging chain can suddenly drag the machine forward if the trencher is forced too quickly into the ground or catches on a buried object.

## SAFETY INSTRUCTIONS OVERVIEW (continued)

Insure that the CHAIN FORWARD/NEUTRAL/REVERSE LEVER is in NEUTRAL when not actually trenching.

 **WARNING:** Contact with the dig chain or auger while in operation will cause serious injury or even death. The teeth of the dig chain are sharp. Avoid contact even when the chain is not moving.

Avoid inclines if at all possible.

 **WARNING:** Navigating on any incline increases the danger of the trencher losing traction or rolling over, especially if the surface is wet. If you lose control get out of the way immediately to avoid personal injury. Navigation on inclines should be especially slow and turns very gradual. Refer to the incline diagram in the section, "GROUND TRANSPORT".

Be careful when using the optional backfill blade to fill in trenches.

 **WARNING:** The weight of the trencher or walking near the edge of the trench could cause collapse of the trench wall. If a track goes over the edge of the trench the trencher could suddenly turn over.

Avoid operating adjacent to drop-offs or embankments.

Keep away from tracks to avoid getting crushed.

 **WARNING:** Getting run over by the trencher will cause injury.

Always leave trencher parked on a level surface.

 **WARNING:** Do not park on incline. Move the trencher to a level surface and set the parking brake located behind the left hand track motor. Move the handle down to engage the brake.

Do not leave trencher unattended with the engine running.

Do not operate trencher near any source of flammable dust or vapors.

 **WARNING:** Sparks from the engine exhaust can cause an explosion or fire in a flammable or explosive atmosphere. Fuel fumes can catch fire or explode.

Do not operate trencher near flames or sparks.

 **WARNING:** Fuel fumes can catch fire or explode.

Shut off engine and allow it to cool before refueling.

 **WARNING:** Fuel fumes can catch fire or explode. Do not smoke when refueling. Do not refuel near a source flames or sparks.

Do not touch the engine, muffler, or any of the hydraulic components until cool.

 **WARNING:** Muffler and engine get hot enough to cause serious burns. For the safety of yourself and others, allow enough time for the engine, muffler, and the hydraulic fluid to cool completely before performing any cleaning or maintenance.

## SAFETY INSTRUCTIONS OVERVIEW (continued)

Avoid contact with hydraulic fluid.



**WARNING:** When machine is operating, hydraulic fluid is under extreme pressure and can get under skin and burn or poison.

Keep others away. If the job site is near a road or pedestrian path, warn and divert both motorized traffic and pedestrians. As appropriate, use traffic flag personnel, signs, cones, and lighting devices to insure safety.



**WARNING:** Someone could step into the trench by accident. Walking near the edge of the trench could cause collapse of the trench wall and possibly cause someone to fall onto the moving chain. Contact with the digging chain or auger while in operation will cause serious injury or even death.

Never allow anybody to ride on the trencher.

Never lift trencher over any person at any time.



**WARNING:** If trencher should fall it would crush anybody under it.

We recommend having a fire extinguisher suitable for petrol fires in the operating area.

Attachments can change the center of mass and machine operations. Use only Barreto attachments.

## BATTERY & ELECTRIC STARTER SAFETY INSTRUCTIONS

Shield entire face, especially your eyes, and wear rubber gloves to avoid acid burns whenever doing anything with the battery. Battery caps must be tightly in place if the battery has removable caps.



**WARNING:** The battery contains sulfuric acid that can cause blindness and severe burns. Avoid contact with eyes, skin, and clothing. If acid contacts eyes, call 911 immediately and flush eyes with water for 15 minutes or until emergency medical help arrives. If acid contacts skin, flush area with plenty of water. If acid is ingested, drink large quantities of water or milk then follow with milk of magnesia, beaten egg, or vegetable oil, and get medical attention immediately.

Avoid contact with battery components. Wear rubber gloves and wash hands after handling any battery components.



**WARNING:** Battery posts, terminals, and related accessories contain lead and lead compounds, chemicals known to cause cancer and reproductive harm. Acid can cause blindness and severe burns if leaked from the battery.

Do not charge or jump-start the battery near flames or sparks, or while smoking.



**WARNING:** Battery fumes are flammable and explosive. Avoid explosion hazard that could blind and burn. Tools and jumper cable clamps can make sparks, so use them with care. Shield eyes and face, and wear rubber gloves.

BATTERY MAINTENANCE is in the OWNER'S MANUAL.

# TRENCHER OPERATING INSTRUCTIONS

READ SAFETY INSTRUCTIONS BEFORE OPERATING! Both the SAFETY INSTRUCTIONS and OPERATING INSTRUCTIONS are in this manual and also on a plastic card attached to the machine

Be sure that the engine oil and fuel, and the machine hydraulic fluid are all at proper levels before starting the engine.

STUDY AND UNDERSTAND CONTROLS BEFORE BEGINNING OPERATION.

## CONTROLS

1. **KEYED IGNITION SWITCH:** This remote switch is located with the other trencher controls for your convenience. Use it to start and stop the engine equipped with an electric starter. Refer to the ENGINE START UP PROCEDURE.
2. **ENGINE:** This is the throttle - controls engine speed. Operate at full throttle (all the way forward).
3. **CLUTCH LEVER:** Located on left handlebar. Squeeze to activate the track drive and dig chain. All motion stops when the lever is released. **DIGGING CHAIN** control must be held in “ON” position as clutch lever is raised in order to activate Dig Chain.
4. **T-HANDLE CONTROL** Controls the travel direction and speed after clutch lever is raised.
  - Pushing the T-handle forward from the neutral position causes the machine to move forward.
  - Pulling the T-handle back from neutral position causes the machine to move backward.
  - Moving the T-handle farther from the neutral position increases the speed.
  - Steer the trencher by twisting the T-handle to the left or right. This causes the track on one side to rotate at a different speed or direction than the opposite track.
  - Very slow speed is required for trenching in most conditions.

NOTE: Be sure operator understands that the machine moves **BACK** when trenching, not forward.
5. **DIG CHAIN ON/OFF CONTROL:** To trench, hold lever in ON position while clutch lever is raised. The ON/OFF lever will stay in position as long as the clutch lever is held. This automatically will activate the **CHAIN FORWARD/REVERSE LEVER** to **FORWARD** position.
6. **CHAIN FORWARD/NEUTRAL/REVERSE LEVER:** Use this lever to reverse chain to help clear debris from the chain. The **DIG CHAIN ON / OFF** lever must be in “OFF” position to put the **CHAIN F/N/R** lever in reverse.
7. **DIGGING BOOM CONTROL:** Pull to raise the digging boom and push to lower the boom. During normal operation you will hear the relief valve working.
8. **PARKING BRAKE:** It is located behind the left hand track motor. Move the handle down to engage the brake, and up to disengage it.

KEYED IGNITION SWITCH  
(KOHLER ENGINE ONLY)

ENGINE THROTTLE  
(KOHLER ENGINE ONLY)

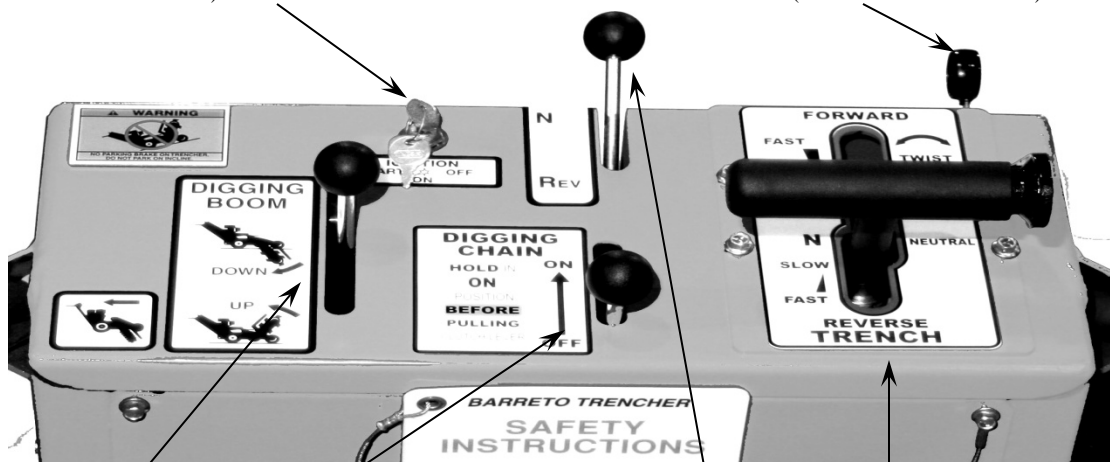

DIGGING BOOM

DIGGING CHAIN

CHAIN FWD/N/REV

T-HANDLE CONTROL

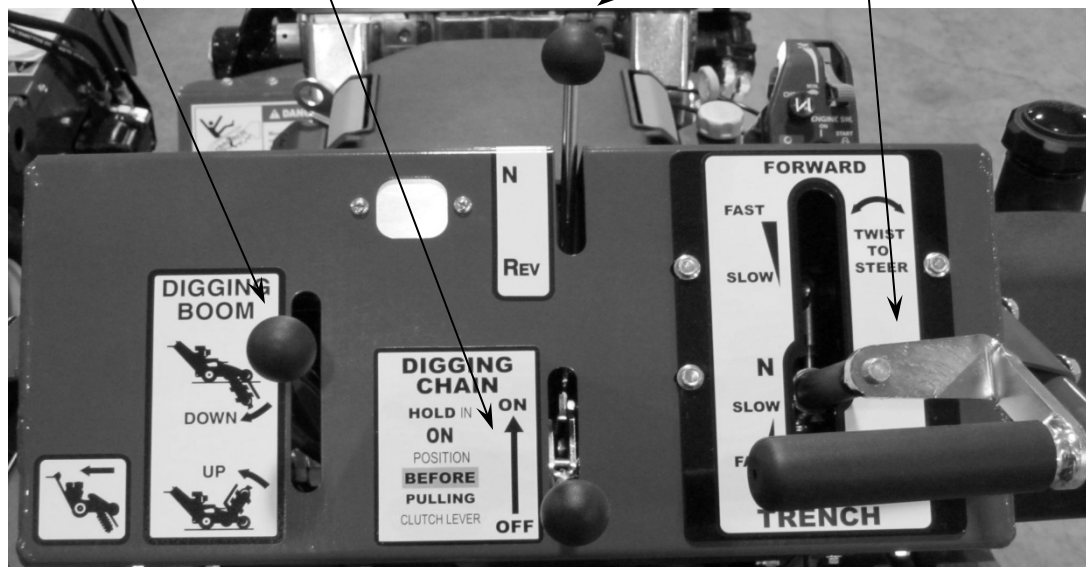

## ENGINE CONTROLS

**FUEL SHUTOFF VALVE:** Must be in OPEN position for engine to run.

**CHOKE:** Use to aid starting the engine when it is cold.

**KEYED IGNITION SWITCH (Kohler Only):** This remote switch is located with the other trencher controls for your convenience. Use it to start and stop the engine equipped with an electric starter. Refer to the ENGINE START UP PROCEDURE.

**ENGINE:** This is the throttle lever (Kohler only). It controls the engine speed. Operate trencher at full throttle (all the way forward).



## ENGINE START UP PROCEDURE

Only operate trencher outdoors and avoid breathing engine exhaust and fumes.



**WARNING:** Engine exhaust contains carbon monoxide gas that is toxic. Breathing it can cause unconsciousness and death. Avoid any areas or actions that expose you to carbon monoxide.

1. Move the CHAIN F/N/R LEVER to NEUTRAL.
2. Move T-HANDLE CONTROL to NEUTRAL.
3. Open the FUEL SHUTOFF VALVE.
4. If the engine is cold, close the CHOKE. Turn choke off (open) after engine warms up enough. To restart a warm engine, leave the choke in the open position.
5. Move the ENGINE THROTTLE to about 1/3 of the way forward.
6. **ELECTRIC STARTER:** Turn the ignition key to the START position, and hold it there until the engine starts. If the engine fails to start within 10 seconds, release the key, and wait at least 10 seconds before operating the starter again.

**NOTICE** - *Using the electric starter for more than 10 seconds at a time will overheat the starter motor and can damage it.*

When the engine starts, release the key, allowing it to return to the ON position.

Open the CHOKE (turn choke off) after the engine warms up enough.

**COLD WEATHER OPERATIONS:** Before operating in cold weather, refer to the Engine Owner's Manual for recommended engine oil. Do not spray starting fluid into the air cleaner as engine damage could result. If the machine is operated at temperatures below +32°F (0°C) then changing the hydraulic fluid to ISO 46 is recommended. If you do not want to change the hydraulic fluid but want to operate the machine at temperatures below +32°F (0°C), then do the following:

- Warm up engine at a low speed.
- Gradually increase engine speed, allowing **30 minutes for the hydraulic fluid to warm up.** Reduce the engine speed if the hydraulic pump whines. Pump noise may indicate a lack of hydraulic fluid flow that could damage the pump.

For frequent starts below 18°F consult your Barreto Manufacturing, Inc. dealer.

## GETTING STARTED

1. Start and warm up engine.
2. Insure that the T-handle control is in neutral.
3. Raise the clutch lever and move the T-handle control to achieve desired speed and direction.
4. Adjust the travel speed and navigate the trencher to the starting position. The trencher is designed to dig toward the operator (with the T-handle control in reverse). With this in mind, position the machine to start the trench.

## TRENCHING PROCEDURE

1. Put the T-handle control in neutral.
2. Have engine at full throttle (lever forward).
3. Hold Dig Chain On/Off Control in the ON position.
4. Raise the clutch lever.
5. Slowly lower the digging boom until the desired trench depth is achieved. See TRENCHING TIPS for details.
6. Put T-handle control in **reverse**. Start at slow speed. The machine moves **BACK** when trenching, not forward.
7. Adjust the travel speed until a workable speed is reached. Use a very slow speed for trenching and adjust for soil conditions as necessary. Adjust speed to avoid track spin or engine overloading. If objects such as rocks or roots jam in the chain, release the clutch lever, then reverse the chain to dislodge the debris. If necessary move the trencher forward a few inches and trench the area again.

## TRENCHING TIPS

### THE PLUNGE CUT:

If the boom bounces when lowering it, use a more gradual “boom down” action. A little ground travel toward the operator during the plunge cut may help reduce bounce. Adjust the boom lowering speed for soil conditions as necessary.

Do not overload engine. If the engine lugs down or the digging chain slows down, raise the boom until speed increases, then continue lowering the boom slowly.

Do not attempt to force boom down faster than digging chain can remove material.

## SHUT DOWN PROCEDURE

1. Always leave trencher parked on a level surface.  
 **WARNING:** Do not park on incline. Move the trencher to a level surface and set the parking brake located behind the left hand track motor, near decal shown. Move the handle down to engage the brake.
2. Move the CHAIN F/N/R LEVER to NEUTRAL.
3. Move the T-HANDLE CONTROL to NEUTRAL.
4. Unless loaded on a trailer, lower the boom to the ground.
5. Reduce the ENGINE THROTTLE to idle.
6. Move the IGNITION KEYED SWITCH to the OFF position to stop the engine, and remove the key.
7. Close the FUEL SHUTOFF VALVE.



Shut off engine and allow it to cool before refueling.

 **WARNING:** Fuel fumes can catch fire or explode. Do not smoke or allow flames or sparks in the area.

Do not touch the engine, muffler, or any of the hydraulic components until cool.



**WARNING:** Muffler and engine get hot enough to cause serious burns. For the safety of yourself and others, allow enough time for the engine, muffler, and the hydraulic fluid to cool completely before performing any cleaning or maintenance.



## JUMP STARTING ENGINE WITH ELECTRIC STARTER

Shield entire face, especially your eyes, and wear rubber gloves to avoid acid burns whenever doing anything with the battery. Battery caps must be tightly in place if the battery has removable caps.



**WARNING:** The battery contains sulfuric acid that can cause blindness and severe burns. Avoid contact with eyes, skin, and clothing. If acid contacts eyes, call 911 immediately and flush eyes with water for 15 minutes or until emergency medical help arrives. If acid contacts skin, flush area with plenty of water. If acid is ingested, drink large quantities of water or milk then follow with milk of magnesia, beaten egg, or vegetable oil, and get medical attention immediately.

Avoid contact with battery components. Wear rubber gloves and wash hands after handling any battery components.



**WARNING:** Battery posts, terminals, and related accessories contain lead and lead compounds, chemicals known to cause cancer and reproductive harm. Acid can cause blindness and severe burns if leaked from the battery.

Do not jump start the battery near flames or sparks, or while smoking.



**WARNING:** Battery fumes are flammable and explosive. Avoid explosion hazard that could blind and burn. Tools and jumper cable clamps can make sparks, so use them with care.

Shield eyes and face, and wear rubber gloves.

Do not jump-start or charge a battery that is frozen or low on electrolyte.

**IMPORTANT:** Use only a 12-volt system for jump-starting. Never allow the vehicle used to jump-start to contact the disabled machine. If the vehicles contact, a spark may occur when the positive jumper cable is connected or disconnected. If equipped with battery caps, they must be in place and tight to reduce risk of battery explosion.

### JUMP STARTING PROCEDURE:

1. Turn ignition switch to OFF.
2. Connect jumper cables in the following order:
  - a) Clamp one RED cable end to the discharged battery POSITIVE (+) terminal.
  - b) Clamp the other end of the RED cable to the booster battery POSITIVE (+) terminal.
  - c) Clamp one BLACK cable end to the booster battery NEGATIVE (-) terminal.
  - d) Clamp the other end of the BLACK cable to the frame of machine with the discharged battery, away from battery.
3. Start the engine.
4. Disconnect the cables in reverse order of connection and cover each jumper cable terminal. To avoid sparks near the battery, never disconnect the red jumper cable without first disconnecting the black jumper cable.

## GROUND TRANSPORT OF THE TRENCHER

Raise the digging chain boom.

Insure that the CHAIN FORWARD/NEUTRAL/REVERSE LEVER is in NEUTRAL when not actually trenching.



**WARNING:** Contact with the dig chain or auger while in operation will cause serious injury or even death. The teeth of the dig chain are sharp. Avoid contact even when the chain is not moving.

Use the T-HANDLE CONTROL to control travel direction and speed after the CLUTCH LEVER is raised.

- Pushing the T-handle forward from the neutral position causes the machine to move forward.
- Pulling the T-handle back from neutral position causes the machine to move backward.
- Moving the T-handle farther from the neutral position increases the speed.
- Steer the trencher by twisting the T-handle to the left or right. This causes the track on one side to rotate at a different speed or direction than the opposite track.
- If you are not experienced operating this trencher, a slow ground speed is recommended for your safety.

Keep away from tracks to avoid getting crushed.



**WARNING:** Getting run over by the trencher will cause injury.

Never allow anybody to ride on the trencher.

Never make sudden changes in speed or direction.

Use extra caution on soft or uneven ground.

Avoid operating adjacent to drop-offs or embankments.

Avoid inclines if at all possible. Never use on any incline exceeding the angles shown below.



**WARNING:** Navigating on any incline increases the danger of the trencher losing traction or rolling over, especially if the surface is wet. If you lose control get out of the way immediately to avoid personal injury. Navigation on inclines should be especially slow and turns very gradual.

A 20° maximum incline is allowed. Honda engines have an Oil Alert system that will automatically stop the engine if tipped more than 20°.

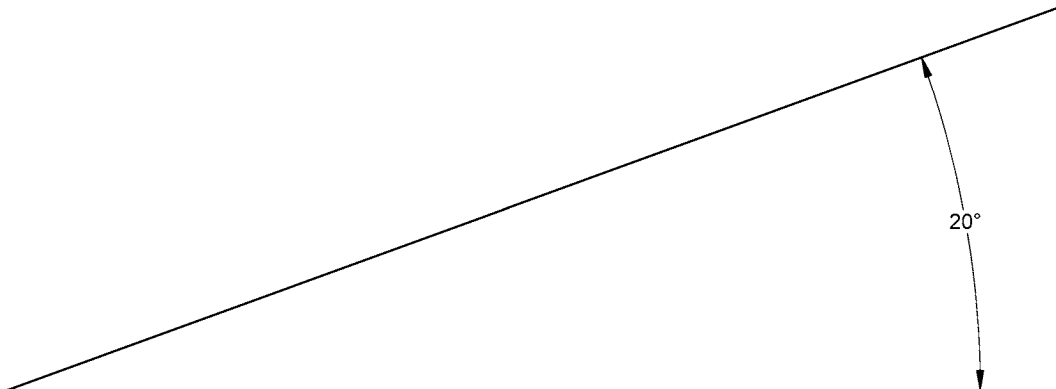

## EMERGENCY TOWING

In case of engine failure there is a provision that allows the trencher to be towed a short distance.

The trencher tracks are driven by a set of tandem pumps. The front pump drives right track, and the other pump drives left track. The drive pump by-pass valves may be opened to allow the machine to be towed.

- Set the parking brake if on a slope to prevent rolling. It is located behind the left hand track motor. Move the handle down to engage the brake.



**WARNING:** Navigating on any slope increases the danger of the trencher losing traction or rolling over, especially if the surface is wet. Stay out of the way to avoid personal injury.

- Loosen (do not remove) the by-pass plugs two complete turns counterclockwise. See diagram for location of plugs.
- Disengage the parking brake by moving the handle up.
- The machine may be towed short distance (1/8 mile or 1/4km) at slow speed, 2 mph or 200 feet per minute maximum (3kph or 60m per min).
- Clutch lever (on left handlebar) must be pulled up and held while towing trencher.
- After towing, close both by-pass valves by closing the plugs with 10 foot-pounds torque.
- Use a trailer or truck for road transport.

If you need to raise the dig chain boom without power, do the following:

1. Loosen the hose at the back port of the boom cylinder and raise the boom end with a hoist or forklift if available.
2. If it still will not lift, then also loosen the hose at the front port of the boom cylinder.



**WARNING:** The boom with dig chain is heavy. Manpower alone is not recommended, but if necessary, use a team of two strong workers to raise the boom, and a third worker to tighten the hose(s) after the boom is up.

3. Secure the boom in the up position with a strap from the boom end to the handlebars.

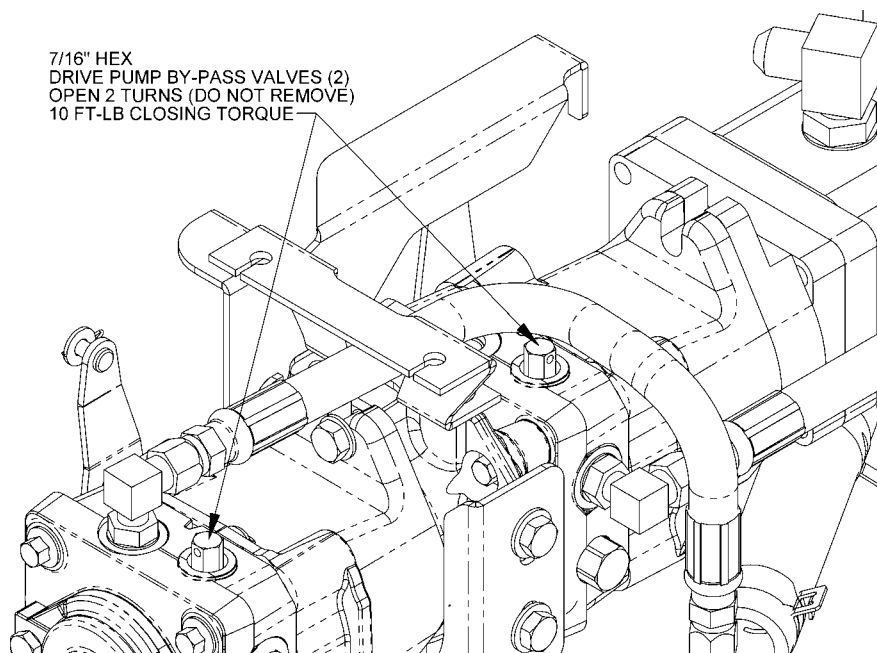

## ROAD TRANSPORT OF THE TRENCHER

The **BEST** way to transport the trencher over roads is with the **BARRETO E4X6 TILT BED TRAILER** and the optional **00340 TIE-DOWN KIT**.

Refer to the following checklist before towing:

- Towing vehicle should have a 2" (5cm) ball. Be sure it is in good repair and securely fastened to the vehicle.
- Securely fasten the hitch to the ball by tightening the hitch nut.
- Thread the safety chain through the loop in the hitch nut handle to prevent it from vibrating loose while towing.
- Attach the safety chain to the towing vehicle in such a way that it cannot come off accidentally.
- Check the hitch-to-ball connection after driving a few blocks and re-tighten if necessary.

Always exercise extreme caution and allow extra clearance while towing a trailer. **DRIVE SAFELY!**

**LOADING PROCEDURE** of the trencher onto the **Barreto E4X6 tilt bed trailer**:

1. Position the tow vehicle and attached trailer on level ground.
2. Unlatch the trailer tilt bed latch pin to tip up the trailer bed. Leave the latch pin where the spring-loaded action will engage the pin with the latch when the bed is leveled again.
3. Line up the trencher with the rear of the trailer. The dig chain should be toward the trailer.
4. Drive the trencher slowly forward onto the trailer bed. As the weight of the trencher reaches the balance point the bed will level itself.

 **WARNING:** Navigating on the inclined trailer bed increases the danger of the trencher tracks losing traction, especially if the bed surface is wet. Stay out of the way to avoid personal injury if you lose control.

5. The chains of the 00340 TIE-DOWN KIT are long enough to adjust for desired trailer tongue weight depending on trencher boom length and type of dig chain, which vary in weight.
6. Loop front chain through D-ring on front of trencher and into keyhole slot in mount.
7. Back up trencher until front chain is tight.
8. Move T-handle control to NEUTRAL.
9. Throttle down and shut off the engine, then close the fuel shutoff valve.

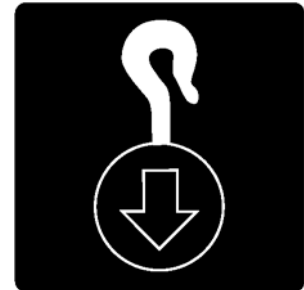

Refer to the **SHUT DOWN PROCEDURE** for details.

10. Loop rear chain through chain loops on rear of trencher and D-rings on trailer.
11. Hook to ratchet load binder and tighten.

The quick link is provided to prevent losing the chain when not in use. Attach it between chain links next to one of the trailer D-rings. Never apply the tie-down load to it.

Check that the trailer tilt bed latch pin is engaged with the latch.

**UNLOADING PROCEDURE** of the trencher from the **Barreto E4X6 tilt bed trailer**:

1. Position the tow vehicle and attached trailer on level ground.
2. Remove all chains or straps connecting the trencher to the trailer D-rings
3. Start the engine using the **ENGINE START UP PROCEDURE**.
4. Unlatch the trailer tilt bed latch pin and rotate the latch pin handle to lock it open.
5. Drive the trencher slowly backward. As the weight of the trencher reaches the balance point the trailer bed will tilt up. Continue backward until tracks are completely on the ground.

## ROAD TRANSPORT OF THE TRENCHER (continued)

 **WARNING:** Navigating on the inclined trailer bed increases the danger of the trencher tracks losing traction, especially if the bed surface is wet. If you lose control, get out of the way to avoid personal injury.

Move the trailer tilt bed latch pin handle so that the spring-loaded action will engage the pin with the latch when the bed is leveled.

LOADING PROCEDURE of the trencher onto a truck bed using ramps:

1. Position the truck and trencher on level ground.
2. Set up suitable ramps, insuring that they are **secure to the back of the truck bed**.
3. Line up the trencher with the ramps with the dig chain pointing away from the back of the truck.  
Drive the trencher slowly backward up the ramps onto the truck bed.

 **WARNING:** Navigating on the ramps increases the danger of the trencher tracks losing traction, especially if the surface is wet. Stay out of the way to avoid personal injury if you lose control.

4. Move T-HANDLE CONTROL to NEUTRAL.
5. Throttle down and shut off the engine, then close the fuel shutoff valve. Refer to the SHUT DOWN PROCEDURE for details.
6. Chain or strap the trencher to the truck using the two chain loops at the rear of the trencher lower body and D-ring on front of trencher.

UNLOADING PROCEDURE of the trencher from a truck bed using ramps:

1. Position the truck on level ground.
2. Set up suitable ramps, insuring that they are **secure to the back of the truck bed**.
3. Remove all chains or straps connecting the trencher to the truck.
4. Start the engine using the ENGINE START UP PROCEDURE.
5. Drive the trencher slowly down the ramps onto the ground.

 **WARNING:** Navigating on the ramps increases the danger of the trencher tracks losing traction, especially if the surface is wet. Stay out of the way to avoid personal injury if you lose control.

LOADING PROCEDURE of the trencher onto a truck bed using a hoist:

Never attempt to hoist the trencher unless suitable equipment is available to lift and lower machine onto the truck. Using the optional **A1570 LIFT EYE** is the **best way** to hoist the trencher. If using a sling, the minimum required working load limit per sling leg is 1000 lb (450 kg). Minimum sling leg length is 6 ft (2 m).

1. Position the truck and trencher on level ground.
2. Follow the trencher SHUT DOWN PROCEDURE.
3. Hook in the optional A1570 LIFT EYE. Or attach lifting sling legs around both rear tie down loops and around the chain motor housing. Ensure machine weight is evenly distributed, then hoist onto the truck bed.

Never lift trencher over any person at any time.

 **WARNING:** If trencher should fall it would crush anybody under it.

4. Chain or strap the trencher to the truck using the two chain loops at the rear of the trencher lower body and D-ring on front of trencher.



# OPERATOR PREPARATION

Each operator must:

- Become familiar with the controls and operation of the trencher, preferably under the supervision of an experienced operator.
- Be at least 18 yrs. of age and be mentally and physically capable of operating the trencher safely.
- Have studied the SAFETY AND OPERATING INSTRUCTIONS in this manual.

**PERSONAL PROTECTION:** For safety, trencher operator should wear personal protection equipment. Keep observers at a safe distance.

Wear safety eye goggles and a hard hat while operating or observing!

 **WARNING:** The dig chain may throw stones and debris.

Wear safety boots and gloves. Wear close-fitting clothing. Contain long hair. Do not wear jewelry. Wear reflective clothing if working near traffic.

Wear adequate hearing (ear) protection while operating or observing.

 **WARNING:** Exposure to loud noise is cumulative and may permanently damage your hearing.



Declared vibration emission value in accordance with EN 12096: the average measured vibration emission value is 4.7 m/s<sup>2</sup>. The uncertainty in the measurement given a 95% confidence interval is 1.1 m/s<sup>2</sup>. Safety gloves help to isolate the hands from the vibration, keep them warm and dry, maintain blood circulation, and make operators less susceptible to vibration induced injury.

Hearing protection devices do not all provide the same level of protection. Those that completely surround each ear are better than earplugs. It is important to select a device that is adequate and appropriate for your specific work environment since the peak noise level varies. A local environmental noise specialist may help you to determine the level of hearing protection required.

<b>DECLARED DUAL-NUMBER NOISE EMISSION VALUES</b>	
<b>in accordance with ISO 4871</b>	
<b>Operating Mode 1</b>	
Measured A-weighted sound power level, L <sub>WA</sub> (ref. 1pW) in decibels	103.7
Uncertainty, K <sub>WA</sub> , in decibels	3.0
Measured A-weighted sound pressure level, L <sub>pA</sub> (ref. 20μPa) at the operator's position in decibels	88.3
Uncertainty, K <sub>pA</sub> , in decibels	3.0
Values determined according to noise test code given in using the basic standard ISO 3744: 1994	Directive 2000/14/EC Annex IIIB part 54
NOTE - The sum of a measured noise emission value and its associated uncertainty represents an upper boundary of the range of values which is likely to occur in measurements.	



## DETERMINE LOCATION OF UNDERGROUND UTILITIES

OSHA CFR 29 1926.651 requires that the estimated location of underground utilities be determined before beginning excavation or an underground drilling operation. When the actual excavation or bore approaches an estimated utility location, the exact location of the underground installation must be determined by a safe, acceptable and dependable method. If any utility cannot be precisely located, the appropriate utility company must shut it off.

**Call before you dig.** If you do not call, you may cause an accident; suffer injuries or death; cause interruption of services; damage the environment; and/or incur project delays. Expect to be held liable for any damages caused, if you fail to call.



**DANGER:** Buried electric cables or gas lines can cause serious injury or death if struck with dig chain. Always determine location of utilities before trenching.



**WARNING:** Fiber optic cables convey laser light that can injure your eyesight.

To locate utilities before trenching call 811 or 1-888-258-0808 (US. or Canada). This free service will provide a “One-Call” number for the geographic area that you select. Before you start any digging project, be sure to call the local One-Call system in your area and any utility company that does not subscribe to the One-Call system. The One-Call representative will notify participating utility companies of your proposed digging activities. Utilities will then mark their underground facilities by using the following international marking codes:

Red	Electric
Yellow	Gas, oil, or petroleum
Orange	Communication, telephone, television
Blue	Potable water
Green/brown	Sewer
White	Proposed excavation
Pink	Surveying

For areas not represented by One-Call Systems International, contact the appropriate utility companies to locate and mark the underground installations. Do not rely on visual evidence of underground utilities such as manhole covers or electrical drop boxes...**CALL!**



**Know what's below.  
Call before you dig.**

# WORK SITE ASSESSMENT

Examine the work area for any conditions or obstructions that may inhibit trenching or create a safety hazard for the operator or others. Use the information in this manual combined with good judgment to identify any hazards to avoid.

In addition to calling to DETERMINE LOCATION OF UNDERGROUND UTILITIES (see previous section for details) the operator and/or job foreman should visually inspect the work site. Look for electrical drop boxes; notices of underground placements; manhole covers; recent trenching activity; any evidence of possible underground placements; banks; overhangs; drop-offs; rocks; tree limbs; wire; uneven terrain; any existing trenches or holes; and toxic ground conditions.

Only operate trencher outdoors and avoid breathing engine exhaust and fumes.



**WARNING:** Engine exhaust contains carbon monoxide gas that is toxic. Breathing it can cause unconsciousness and death.

Do not operate trencher near any source of flammable dust or vapors.



**WARNING:** Sparks from the engine exhaust can cause an explosion or fire in a flammable or explosive atmosphere. Fuel fumes can catch fire or explode.

Allow adequate side and overhead clearances between trencher and any objects such as buildings, fences, and trees.



**WARNING:** If the dig chain contacts an object the digging chain can climb upward quickly and tip the trencher toward the operator. Serious injury or death will result by operator contact with the moving chain or auger. The digging chain can suddenly drag the machine forward if the trencher is forced too quickly into the ground or catches on a buried object.

Adequate lighting is required, daylight or artificial, for safe operation of the trencher.

Keep others away. If the job site is near a road or pedestrian path, warn and divert both motorized traffic and pedestrians. As appropriate, erect barriers, use traffic flag personnel, signs, cones, and lighting devices to insure safety.



**WARNING:** Someone could step into the trench by accident. Walking near the edge of the trench could cause collapse of the trench wall and possibly cause someone to fall onto the moving chain. Contact with the digging chain or auger while in operation will cause serious injury or even death.

**MACHINE FUNCTION CHECK:** If the operator releases CLUTCH LEVER while the TRACK DRIVE or DIG CHAIN is engaged, these functions should stop. This is intended for your safety and must be maintained in good functional condition. Contact your dealer if anything on the trencher does not function properly.

## CONTACT WITH UNDERGROUND UTILITIES

After LOCATING UNDERGROUND UTILITIES and performing the WORK SITE ASSESSMENT, accidental dig chain contact with a buried utility might still occur. If it does, stop digging and call 911 for help.

If you cut a wire or cable, assume that you do not know what kind it is. It may be electrical or any one of several communication lines: telephone, television, or fiber optic. In any case, do not touch it or even look at the ends of it. Stop digging and call 911 for help. Do not dig any more until the appropriate utility company has assessed the situation, taken appropriate action, and informed you that is safe to proceed.

If you strike a pipe, it could be gas, oil, petroleum, water, or sewer. In any case, stop digging, shut off the engine, and evacuate the area immediately. Call 911 for help.

Electrical wires or cables: If you think that you may have severed electrical wires, stop digging and call 911 for help. Keep yourself and other people away from the area.



**DANGER:** An electric shock could kill you. Assume that any severed wire or cable is HOT with voltage and do not touch it!

Gas lines: If you think that you may have struck a gas line, shut off the engine and evacuate the area immediately. Call 911 for help.



**DANGER:** A gas explosion could kill you. Sparks will likely occur from the dig chain scraping the metal pipe. If gas leaks out an explosion could easily occur.

Fiber optic cables: If you think that you may have severed a fiber optic cable, do not touch or even look at the ends of it.



**WARNING:** Fiber optic cables convey laser light that can injure your eyesight. Call 911 for help.

## INDEX

- BATTERY, 6
- boom, 7, 10, 12, 13
- Call before you dig**, 17
- CHAIN FORWARD/NEUTRAL/REVERSE, 5, 7, 12
- CHOKE, 8, 9
- CLUTCH LEVER, 4, 7, 12, 18
- COLD WEATHER OPERATIONS, 9
- CONTROL, 12
- CONTROLS, 7
  - decals, 3
- DIG CHAIN ON/OFF CONTROL, 7
- DIGGING BOOM CONTROL, 7
- ELECTRIC STARTER, 9
- EMERGENCY TOWING, 13
- ENGINE, 7, 8, 9, 10, 14, 15
- ENGINE CONTROLS, 8
- FUEL SHUTOFF VALVE, 8, 9, 10
  - grease, 2
- GROUND TRANSPORT, 12
  - hearing protection, 4, 16
  - hoist, 15
  - hydraulic fluid, 5, 6, 7, 9, 11
- IGNITION, 10
- IGNITION SWITCH, 7, 8
- JUMP STARTING, 11
- LOADING, 14, 15
- LUBRICATION, 2
  - Navigating, 5, 12, 13, 14, 15
- OPERATING INSTRUCTIONS, 7, 16
- OPERATOR PREPARATION, 16
  - parking brake, 5, 10, 13
- PARKING BRAKE, 7
- PERSONAL PROTECTION, 16
- PLUNGE CUT, 10
  - protection, 4, 16
  - ramps, 15
  - refueling, 5, 10
- ROAD TRANSPORT, 14
  - safety goggles, 4, 16
- SAFETY INSTRUCTIONS, 4, 5, 6, 7
- SAFETY MESSAGES, 3
  - safety shoes, 4, 16
- SHUT DOWN, 10, 14, 15
  - starting, 7, 8, 9
  - Steer, 7, 12
  - temperature, 9
- T-HANDLE CONTROL, 7
  - throttle, 7, 8, 10
- THROTTLE, 9, 10
  - tires, 14, 15
- TOWING. *See* EMERGENCY TOWING
  - track drive, 7
  - trailer, 10, 13, 14, 15
  - transport, 13, 14
- TRANSPORT. *See* GROUND TRANSPORT
- TRENCHING, 10
- UNDERGROUND UTILITIES, 17, 18, 19
- UNLOADING, 14, 15
- WHEEL CONTROLS, 10, 14, 15
- WORK SITE, 18, 19