

# nifty

# Heightrider

Operating & Safety Instructions

**MODEL HR12 (SP34) SERIES  
MK2**

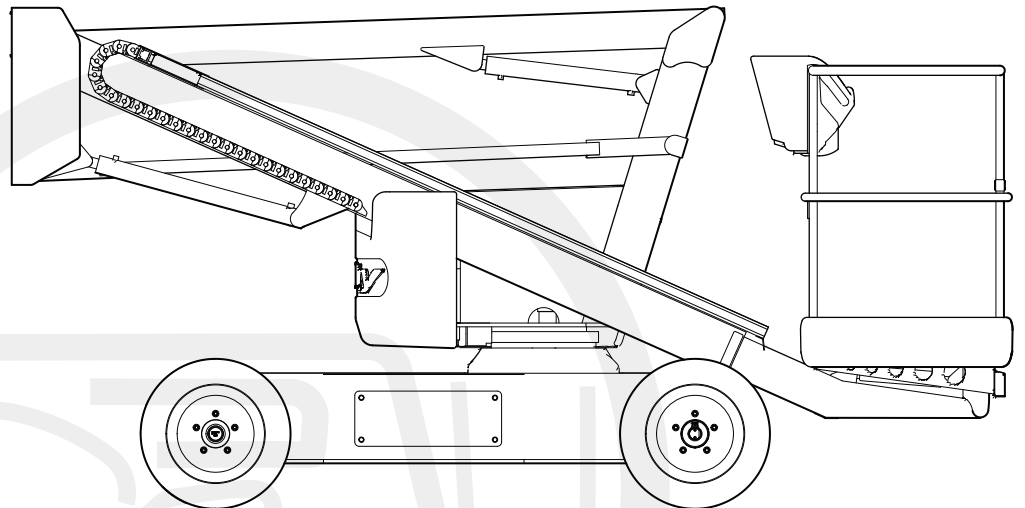

Manufactured by:  
**Niftylift Limited**  
Chalkdell Drive  
Shenley Wood  
Milton Keynes  
MK5 6GF  
England

www.niftylift.com  
e-mail: info@niftylift.com  
Tel: +44 (0)1908 223456  
Fax: +44 (0)1908 312733



**niftylift.com**  
info@niftylift.com

M50512/02



# HR12 MK2 EMERGENCY PROCEDURES

## Emergency Stop

- 1) Push in red emergency stop to shut down all machine movement.
- 2) Release both emergency stops to restore normal controls.

## Recovery from Base Controls

If normal controls are available (Fastest recovery time):

- 1) Switch to base, press green button and operate desired function lever(s).

If normal controls are not available:

- 2) Locate manual hand pump under control canopy.
- 3) Attach supplied handle to hand pump.
- 4) Move and hold desired boom function lever in required direction.
- 5) Pump hand pump to activate selected function.
- 6) Release lever and stop pumping to halt machine movement.
- 7) If the cage has contacted a fixed object and cage overload has disabled the machine, move machine slightly using steps 2-6. The overload alarm and visual warning will cease once normal controls are available.
- 8) If normal controls are still not available, continue pumping to lower machine manually.

## Recovery from Cage Controls

- 1) Press white override button situated on the cage console.  
Override mode is for **booms only** and will not operate drive.
- 2) Activate a single desired function paddle.  
(Note: Multiple boom function is not available in override mode).
- 3) If the cage has contacted a fixed object and cage overload has disabled the machine, move machine slightly using steps 1-2. The overload alarm and visual warning will cease and normal controls are available.
- 4) Use normal controls if available for fastest recovery time.  
Press green button or footswitch and operate desired function lever(s).
- 5) If normal controls are not available, continue using override button to lower machine using auxiliary power.

## SiOPS

If white button is flashing (SiOPS is active and cage is overloaded):

- 1) Follow procedure described in 'Recovery from Cage Controls' until green button flashes or normal operation is restored.

If green button is flashing (SiOPS is active):

- 2) Press flashing green button and operate cage controls to manoeuvre machine to a safe position.

To reset footswitch and normal controls:

- 1) Release load from front of console.
- 2) Ensure cage controls are in neutral position and clear of objects.
- 3) Raise foot clear of footswitch then lower foot onto footswitch to reactivate.

**Note:** If footswitch is not reset within **15 seconds**, then blue beacon on underside of cage will flash and a warning announcement will sound until footswitch is reset as described.

**For further information on all controls refer to Sections 4.2 and 4.3.**

Emergency lowering instructions vary between different types of Mobile Elevating Work Platform. Niftylift recommend that operators, site-safety personnel, and ground workers are trained in and practise these machine-specific procedures.

# Table of Contents

<b>1</b>	<b>Introduction and General Information</b>	<b>2</b>
1.1	FOREWORD .....	2
1.2	SCOPE.....	3
1.3	INTRODUCING THE HEIGHT RIDER SELF-PROPELLED (SP) SERIES.....	3
1.4	GENERAL SPECIFICATION.....	4
1.5	IDENTIFICATION (UK PLATE) .....	5
1.6	EC DECLARATION OF CONFORMITY (Typical) .....	7
<b>2</b>	<b>Safety</b>	<b>8</b>
2.1	MANDATORY PRECAUTIONS .....	8
2.2	ENVIRONMENTAL LIMITATIONS.....	12
2.3	NOISE AND VIBRATION .....	12
2.4	TEST REPORT .....	13
<b>3</b>	<b>Preparation and Inspection</b>	<b>14</b>
3.1	UNPACKING.....	14
3.2	PREPARATION FOR USE .....	14
3.3	PRE-OPERATIONAL SAFETY CHECK SCHEDULES .....	15
3.4	PLACARD, DECALS & INSTALLATION (UK SPEC) .....	18
3.5	TORQUE REQUIREMENTS.....	20
<b>4</b>	<b>Operation</b>	<b>21</b>
4.1	CONTROL CIRCUIT COMPONENTS .....	21
4.2	GROUND CONTROL OPERATION.....	23
4.3	PLATFORM CONTROL OPERATION .....	26
4.4	DRIVING CONTROLS.....	35
4.5	CAGE WEIGH SYSTEM.....	36
4.6	BATTERIES AND CHARGING .....	37
4.7	TRANSPORTING, TOWING, CRANEAGE, STORAGE AND SETTING TO WORK..	40
<b>5</b>	<b>Emergency Controls</b>	<b>43</b>
5.1	GENERAL .....	43
5.2	IN THE EVENT OF AN INCAPACITATED OPERATOR .....	43
5.3	IN THE EVENT OF MACHINE FAILURE .....	43
5.4	INCIDENT NOTIFICATION.....	43
<b>6</b>	<b>Responsibilities</b>	<b>44</b>
6.1	CHANGES IN OWNERSHIP .....	44
6.2	MANUAL OF RESPONSIBILITIES (USA only) .....	44
6.3	INSPECTION/SERVICE/PRE-HIRE CHECK LIST .....	45
	<b>Appendix A</b>	<b>48</b>
	<b>Appendix B</b>	<b>53</b>

# 1 Introduction and General Information

## 1.1 FOREWORD

The purpose of these manuals is to provide the customer with appropriate safety operating and maintenance instructions essential for proper machine operation.

All information in these manuals should be **READ** and fully **UNDERSTOOD** before any attempt is made to operate the machine. **THESE MANUALS ARE VERY IMPORTANT TOOLS** - Keep them with the machine at all times.

**The manufacturer has no direct control over machine application and use, therefore conformance with good safety practices is the responsibility of the user and his operating personnel.**

**All information in these manuals is based on the use of the machine under proper operating conditions. Alteration and/or modification of the machine are strictly forbidden.**

**One of the most important facts to remember is that any equipment is only as safe as those who operate it.**

### **DANGER, WARNING, CAUTION, IMPORTANT, INSTRUCTIONS AND NOTICE**

Any place these topics may appear, either in this manual or on the machine, they are defined as follows:

**DANGER:** If not correctly followed there is a high probability of serious injury or death to personnel.

**WARNING OR CAUTION:** If not correctly followed there is some possibility of serious injury or death to personnel.



THE '**SAFETY ALERT**' SYMBOL IS USED TO CALL ATTENTION TO POTENTIAL HAZARDS THAT MAY LEAD TO SERIOUS INJURY OR DEATH, IF IGNORED.

**IMPORTANT AND INSTRUCTIONS:** Denotes procedures essential to safe operation and prevention of damage to or destruction of the machine.

**NOTICE:** Indicates general safety rules and/or procedures relating to the machine.

**It is the owner's/user's responsibility to know and comply with all applicable rules, regulations, laws, codes and any other requirements applicable to the safe use of this equipment.**

## **1.2 SCOPE**

These operating instructions contain all the necessary information required to allow the safe operation of any Niftylift Height Rider 12 MK2 (SP34 in the USA) powered by DC electric (E).

For further technical information, circuit diagrams and specific instructions for all maintenance which may need to be carried out by specialist trained personnel, see the associated Workshop and Parts manual for your model of Niftylift Height Rider.

## **1.3 INTRODUCING THE HEIGHT RIDER SELF-PROPELLED (SP) SERIES**

Please note at the time of going to press all information, illustrations, details and descriptions contained herein are valid. Niftylift reserves the right to change, modify or improve its products without any obligations to install them on previously manufactured machines.

If, after reading this manual you require further information, please do not hesitate to contact us.

**Niftylift Ltd, Chalkdell Drive, Shenley Wood, Milton Keynes MK5 6GF, Great Britain**  
**Tel: +44 (0) 1908 223456 Fax: +44 (0) 1908 312733**

**Niftylift Inc, 1525 S. Buncombe Road, Greer, SC 29651 USA**  
**Tel: +01 864 968 8881 Fax: +01 864 968 8836**

**Nifty Pty Ltd, 11 Kennington Drive, Tomago, NSW 2322, Australia**  
**Tel: +61 (0) 2 4964 9765 Fax: +61 (0) 2 4964 9714**

Driven from the platform, the Niftylift Height Rider 12 MK2 (SP34) is an extremely versatile articulated boom platform of unique and simple design. The HR12 can place two people and their tools at a height of 10.2m (33ft 4in) or an outreach of 6.3m (20ft 9in).

The booms are mounted via a 355<sup>0</sup> powered swing mechanism onto a compact narrow base with a tight turning circle that ensures excellent manoeuvrability and maximum efficiency.

High traction tyres and powerful electric wheel motors give unsurpassed performance with the option of fast drive speed when the booms are in the stowed position. Automatic braking and audible alarms activated by a tilt sensor help to prevent the operator from working on unsafe terrain whilst elevated.

A digital control system gives smooth, reliable movement of the platform and maximum reliability in the harshest environments.

*Models include the following:*

E: - DC ELECTRIC

**Operating & Safety Instructions****1.4 GENERAL SPECIFICATION**

<b>FEATURE</b>	<b>HR12LE MK2</b>	<b>HR12NE MK2</b>
MAXIMUM HEIGHT - WORKING	12.1m 39ft 6in	
MAXIMUM HEIGHT - PLATFORM	10.2m 33ft 4in	
MAXIMUM OUTREACH	6.34m 20ft 9in	
MAXIMUM HEIGHT – STOWED	1.98m 6ft 5in	
MAXIMUM WIDTH	1.49m 4ft 11in	
MAXIMUM LENGTH – STOWED	3.97m 13ft 1in	
PLATFORM CAPACITY - Europe	200kg (440lbs)	
WHEELBASE	1.90m 6ft 3in	
TURNING RADIUS – OUTSIDE	3.31m 10ft 9in	
TURRET ROTATION	405°	
TURRET TAIL SWING	Zero	
TRAVEL SPEED	0 - 2.3mph 0 - 3.7kph	
PLATFORM SIZE	0.84m x 1.2m 33in x 47in	
HYDRAULIC PRESSURE	210bar	
TYRES	Solid	
GRADEABILITY	25%	
MINIMUM VEHICLE WEIGHT	2470kg 5445lbs	3220kg 7099lbs
MAXIMUM GROUND PRESSURE	0.040kN/cm <sup>2</sup> 8416lb/ft <sup>2</sup>	0.052kN/cm <sup>2</sup> 10968lb/ft <sup>2</sup>
POINT LOAD	15.7kN	19.9kN
MAXIMUM ALLOWABLE INCLINATION	3.0°	
POWER SOURCE	E (Battery) - 4 x 13.2V 100Ah batteries	E (Battery) - 8 x 6V 220Ah batteries

## 1.5 IDENTIFICATION (UK PLATE)

			
NIFTYLIFT LTD. RINGLE DRIVE, STONEBRIDGE MILTON KEYNES MK13 0ER ENGLAND TEL 01908 223456 : FAX 01908 312733 e-mail : info@niftylift.com			
SERIAL No			
TYPE			
YEAR OF MANUFACTURE			
WEIGHT			kg
RATED LOAD	PERSONS	+	kg
MAXIMUM SAFE WORKING LOAD			kg
MAXIMUM PULL			N
MAXIMUM WIND SPEED			m/s
MAX. ALLOWABLE INCLINATION			Deg.
MAXIMUM HYDRAULIC PRESSURE			bar
MAXIMUM VOLTAGE			V
AMPS			A
ELEC. CCT D	ISSUE		
HYD. CCT D	ISSUE		
			P10205

**This manufacturer's plate is attached to the chassis on each machine at the time of manufacture on every Niftylift. Please ensure all sections have been stamped and are legible.**

# **nifty** Height Rider/SP Series

## Operating & Safety Instructions

### 1.5a IDENTIFICATION (USA PLATE)

	
NIFTYLIFT LTD. RINGLE DRIVE, STONEBRIDGE MILTON KEYNES MK13 0ER GREAT BRITAIN TEL (01144) 1908 223456 : FAX (01144) 1908 312733 e-mail : info@niftylift.com	
THIS WORK PLATFORM COMPLIES WITH ANSI STANDARD A 92-	
MODEL	
SERIAL NO	
YEAR OF MANUFACTURE	
CAPACITY RATING	LBS
PLATFORM HEIGHT	FEET
GROSS WEIGHT	LBS
MAXIMUM HYDRAULIC PRESSURE	PSI
MAXIMUM VOLTAGE	V
AMPS	A
ELEC. CCT D	ISSUE
HYD. CCT D	ISSUE
P11497	

**This manufacturer's plate is attached to the chassis on each machine at the time of manufacture on every Niftylift. Please ensure all sections have been stamped and are legible.**



## 1.6 EC DECLARATION OF CONFORMITY (Typical)



---

**EC DECLARATION OF CONFORMITY**

---

MANUFACTURER AND PERSON RESPONSIBLE FOR DOCUMENTATION:	NIFTYLIFT LTD *****
ADDRESS:	CHALKDELL DRIVE, SHENLEY WOOD, MILTON KEYNES, MK5 6GF, ENGLAND.
MACHINE TYPE:	MOBILE ELEVATING WORK PLATFORM
MODEL TYPE:	*****
SERIAL NUMBER:	*****
APPROVED BY:	NIFTYLIFT LTD CHALKDELL DRIVE, SHENLEY WOOD, MILTON KEYNES, MK5 6GF, ENGLAND
TECHNICAL FILE NUMBER:	*****
APPLICABLE STANDARDS:	BS EN 280:2013+A1:2015, BS EN 60204-1:2006+A1:2009 BS EN ISO 13849-1:2008

*We hereby declare that the above mentioned machine conforms with the requirements of the Machinery Directive, 2006/42/EC and EMC Directive 2014/30/EU.*

SIGNED:

DATE:

\*\*\*\*\*

NAME:

Steven Redding

POSITION:

Development Director

**NOTE:**

THIS DECLARATION CONFORMS WITH THE REQUIREMENTS OF ANNEX II-1.A OF THE COUNCIL DIRECTIVE 2006/42/EC ANY MODIFICATIONS TO THE ABOVE MENTIONED MACHINE WILL INVALIDATE THIS DECLARATION, AND THE MACHINE'S APPROVAL.

## **2 Safety**

### **2.1 MANDATORY PRECAUTIONS**

When operating the Niftylift, your safety is of utmost concern. In order to fully appreciate all aspects of the machine's operation it should be ensured that each operator has **READ** and fully **UNDERSTOOD** the relevant manual covering machine use, maintenance and servicing. If any doubts exist concerning any points covered in this manual, contact your local dealer or Niftylift Ltd.

Before using any Niftylift, thoroughly inspect the machine for damage or deformation to all major components. Likewise, check the control systems for hydraulic leaks, damaged hoses, cable faults or loose covers to electrical components. At no time should damaged or faulty equipment be used - Correct all defects before putting the platform to work. If in doubt, contact your local dealer or Niftylift Ltd (see front cover for address).



**THE MANUFACTURER HAS NO DIRECT CONTROL OVER THE MACHINE APPLICATION AND USE. THEREFORE CONFORMITY WITH GOOD SAFETY PRACTICES IS THE RESPONSIBILITY OF THE USER AND HIS OPERATING PERSONNEL. FAILURE TO UNDERSTAND AND FOLLOW ALL SAFETY RULES COULD RESULT IN SERIOUS INJURY OR DEATH.**

- 2.1.1** Only trained persons are permitted to operate the Niftylift.
- 2.1.2** Always operate the Niftylift in accordance with these model-specific Operating & Safety Instructions.
- 2.1.3** Before use each day and at the beginning of each shift the Niftylift shall be given a visual inspection and functional test including, but not limited to, operating and emergency controls, safety devices, personal protective clothing, including fall protection, air, hydraulic and fuel system leaks, cables and wiring harness, loose or missing parts, tyres and wheels, placards, warnings, control markings and Operating and Safety Manuals, guards and guard rail systems and all other items specified by the manufacturer.
- 2.1.4** Any problems or malfunctions that affect operational safety must be repaired prior to use of the platform, with specific regard to any safety components refer to the Parts Manual for part numbers and details. If in doubt, contact Niftylift Ltd (Details on page 3). **Ensure wheels are chocked before carrying out any maintenance that involves gearbox disengagement as described in Section 4.7.2**
- 2.1.5** Always ensure that all warning labels, instructions, placards, control markings and Operating & Safety Manuals are intact and clearly legible. If replacements are required contact your local dealer or Niftylift. **Always obey the safety and operating instructions on labels.**
- 2.1.6** Do not alter, modify, or disable in any way the controls, safety devices, interlocks, or any other part of the machine.
- 2.1.7** The user must ensure that, prior to and during use, the working area and transport route is free from possible hazards such as, but not limited to, uneven ground drop-offs, holes, bumps, obstructions, debris, floor and overhead obstructions, high voltage conductors, wind and weather, unauthorised persons and any other possibly hazardous conditions.

- 2.1.8** This machine contains several hazardous substances such as but not limited to: Battery acid, Hydraulic Fluid, Engine Coolant, Antifreeze, Diesel Fuel, Petrol, Engine Oil, Grease, Gasoline.
- 2.1.9** Covers and canopies should remain closed when the machine is in operation. Only trained personnel should carry out maintenance on the machine, ensuring at all times they protect themselves from electrical, heat and mechanical hazards.
- 2.1.10** Never exceed the maximum platform capacity, as indicated on the decals and machine serial plate.
- 2.1.11** Only operate the Niftylift on a firm, level surface.
- 2.1.12** Never position any part of the Niftylift inside the **Minimum approach distances** (MAD) to above-ground electrical conductors as listed in the table below. (Reference ISO 18893:2014).

<b>Voltage range (kV)</b>	<b>MAD (m)</b>
<0.7	1
≥0.7 to 7	1.2
>7 to 50	3
>50 to 220	4
>220 to 500	5
>500 to 750	10
>750 to 1000	13
>1000 to 1250	16

**THIS MACHINE IS NOT INSULATED.**

If in doubt, contact the local appropriate governing authority.

- 2.1.13** On entering the platform ensure that the drop down entry bar is closed afterwards.
- 2.1.14** Use of an approved full-body harness and short lanyard, hard hat and appropriate safety clothing is mandatory. Fasten harness to designated harness securing points within the platform and do not remove until leaving the platform whilst in the stowed position. **Note**; if working next to or over water, the risk of injury from either falling or drowning must be assessed. Then the decision can be made if it is appropriate to wear a harness.
- 2.1.15**  Always remain standing within the platform. Do not attempt to increase your height or reach by standing and/or climbing on the platform guard rails or any other object. **KEEP YOUR FEET ON THE PLATFORM FLOOR.** Do not sit, stand or climb on the guard rail, mid rail or boom linkage. Use of planks, ladders or any other devices on the Niftylift for achieving additional height or reach shall be prohibited.
- 2.1.16** Do not use the platform levelling system to artificially increase the outreach of the platform. Never use boards or ladders in the platform to achieve the same result.
- 2.1.17** Do not use the platform to lift overhanging or bulky items that may exceed the maximum capacity or carry objects that may increase the wind loading on the platform. (e.g. Notice boards etc.)

## **nifty** Height Rider/SP Series

---

### **Operating & Safety Instructions**

- 2.1.18** The Niftylift shall not be operated from a position on trucks, trailers, railway cars, floating vessels, scaffolds or similar equipment unless the application is approved in writing by Niftylift Ltd in Great Britain.
- 2.1.19** Always check that the area below and around the platform is clear of personnel and obstructions before lowering or slewing. Care should be taken when slewing out into areas where there may be passing traffic. Use barriers to control traffic flow or prevent access to the machine.
- 2.1.20** Stunt driving and horseplay, on or around the Niftylift, is not permitted.
- 2.1.21** When other moving equipment or vehicles are present, special precautions shall be taken to comply with local ordinances or safety standards established for the work place. Warnings, such as but not limited to, flags, roped off areas, flashing lights and barricades shall be used.
- 2.1.22** Before and during driving while the platform is elevated, the operator shall maintain a clear view of the path of travel, maintain a safe distance from obstacles, debris, drop offs, holes, depressions, ramps and other hazards to ensure safe elevated travel. Maintain a safe distance from overhead obstacles.
- 2.1.23** The aerial platform is not equipped for or intended for use on a public highway.
- 2.1.24** Under all travel conditions the operator shall limit travel speed according to conditions of ground surface, congestion, visibility, slope, location of personnel and other factors causing hazards of collision or injury to personnel.
- 2.1.25** The aerial platform shall not be driven on grades, side slopes or ramps exceeding those for which the aerial platform is rated by the manufacturer.
- 2.1.26** It shall be the responsibility of the user to determine the hazard classification of any particular atmosphere or location. Aerial platforms operated in hazardous locations shall be approved and suitable for the duty. (See ANSI/NFPA 505 where applicable).
- 2.1.27** The operator shall immediately report to his supervisor any potentially hazardous location(s) (environment) which become evident during operation.
- 2.1.28** If an operator encounters any suspected malfunction of the Niftylift or any hazard or potentially unsafe condition relating to capacity, intended use or safe operation, they shall cease operation of the Niftylift and request further information as to safe operation from their management, or owner, dealer or manufacturer before further operation of the Niftylift.
- 2.1.29** The operator shall immediately report to their superior any problems or malfunctions of the Niftylift, which becomes evident during operation. Any problems or malfunctions that affect the safety of operation shall be repaired prior to continued use.
- 2.1.30** The boom and platform of the Niftylift shall not be used to jack the wheels off the ground.
- 2.1.31** The Niftylift shall not be used as a crane.
- 2.1.32** The Niftylift shall not be positioned against another object to steady the platform.
- 2.1.33** Care should be taken to prevent rope, electrical cords and hoses from becoming entangled in the aerial platform.
- 2.1.34** Batteries shall be recharged in a well-ventilated area free of flame, sparks or other hazards (e.g. do not smoke near the machine), which may cause explosion. Highly explosive hydrogen gas is produced during the charging process.

**2.1.35** If the platform or elevating assembly becomes caught, snagged or otherwise prevented from normal motion by adjacent structure or other obstacles, such that control reversal does not free the platform, all personnel shall be removed from the platform safely before attempts are made to free the platform using ground controls.

**2.1.36**  When the machine is not in use always stow the booms correctly. **NEVER LEAVE THE KEY IN THE MACHINE**, if it is to be left for any period of time. Use wheel chocks if leaving on an incline.

**2.1.37** The engine must be shut down while fuel tanks are being filled. Fuelling must be done in a well-ventilated area free of flame, sparks or any other hazard that may cause fire or explosion. **PETROL (GASOLINE) AND DIESEL FUELS ARE FLAMMABLE.**

**2.1.38**  **NEVER START THE NIFTYLIFT IF YOU SMELL PETROL (GASOLINE), LIQUID PROPANE OR DIESEL FUEL. THESE FUELS ARE HIGHLY FLAMMABLE**

**2.1.39** The operator must ensure that engine powered machines are used in a well-ventilated area to minimise the risk of carbon monoxide poisoning.

**2.1.40** The operator shall implement means provided to protect against use by unauthorised persons.

**2.1.41** Never remove anything that may affect the stability of the machine such as, but not limited to, batteries, covers, engines, tyres or ballast.

**2.1.42** The operator must ensure that the controls are not obstructed (e.g. by tools or equipment) and **clear access to the Emergency Stop** is available at all times.

**2.1.43** All persons in the cage must take suitable precautions to prevent items falling or being ejected from the cage. E.g. Tethering tools to the machine or operator if practical and an assessment of any resulting risks is acceptable.

**2.1.44** Hydraulic oil escaping under pressure can penetrate the skin and cause **serious injury**. Do not allow hydraulic oil to squirt or spray. **Seek immediate medical attention in the event of hydraulic oil penetrating the skin.** Wear chemical-resistant protective gloves and suitable eye protection when handling hydraulic oil. Relieve system pressure before removing any hydraulic connections, undo fittings slowly to make sure there is no residual pressure. If pressure is detected, allow it to be released slowly before completely removing hose. Fluid leaks may not be visible to the naked eye. Use a piece of cardboard to check for leaks, not your hand. **Never** install hydraulic lines or components that are damaged.

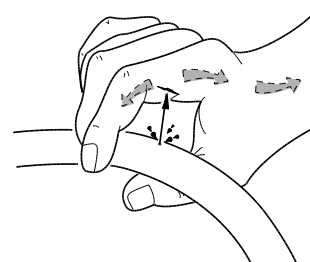

**2.1.45** The HR12 MK2 has been tested in a UKAS accredited electromagnetic compatibility (EMC) chamber and complies with the relevant clauses of EN61326-3-1:2008, EN61000-6-2:2005 for emissions and immunity. Niftylift offer a generator option on this machine, but cannot control the device that is connected to the system or the resulting variation in the amplitude of electrical noise produced when operating the generator. Niftylift therefore recommend that the generator is not used when the machine is located near any equipment that may be sensitive to electromagnetic disturbance.

**Operating & Safety Instructions**

**2.2 ENVIRONMENTAL LIMITATIONS**

Unless specifically configured otherwise, the machine will have a short operational time in extreme temperatures such as freezers and cold storage, due to reduced battery performance. For electrical cables and components, the temperature must be within the range -5°C to 60°C.

The machine is limited in high temperatures because of the cooling requirement for engines and hydraulic oil. Coolant temperatures must be within the range -37°C to 110°C (at 50% mixture of water to anti-freeze). Oil temperature must not exceed -23°C to 93°C.

**The recommended operational range for these machines is - 5°C to +30°C. Please contact Niftylift Ltd for special considerations if the machine is required to operate outside these temperatures.**

Extended operation in dusty environments is not recommended; frequent cleaning will be necessary. All dust, dirt, salt encrustation, excess oil or grease should be removed. Deposits of paint or bitumen, particularly on legends or labels should be removed.

All standard Niftylift machines are rated for a wind speed of 12.5 m/s, which equates to 45kph / 28mph or force 6 on the Beaufort scale. No attempt should be made to operate a Niftylift in wind strengths above this limit and if the operator has any doubts over the wind speed they should cease operation immediately until it can be established that the wind speed has fallen to a safe level.



**DO NOT USE THE NIFTYLIFT IN ELECTRICAL STORMS**

**2.3 NOISE AND VIBRATION**

The average A-weighted sound pressure levels measured at the operator control positions during normal machine operating conditions are shown in the table below:

<b>Operation mode and location</b>	<b>A-rated sound pressure level</b>
Booms from ground controls	60-65 dBA
Booms from cage controls	60-64 dBA
Drive from cage controls (Booms stowed)	72-78 dBA

In normal operation the vibration level to which the operator is subjected will not exceed a weighted root mean square acceleration value of 2.5 m/s<sup>2</sup>.

## 2.4 TEST REPORT

All Niftylift machine models are subjected to a comprehensive 'type test' which examines the worst-case combination of safe working load (SWL), overload, windage, inertia and pull force to assess the various safe stability criteria. Self-propelled machines are also subjected to kerb and braking tests at the SWL to satisfy additional dynamic stability requirements.

Each individual machine is then subjected to static overload tests on flat level ground with 150% of the SWL, exceeding the requirements of BS EN280:2013+A1:2015 for power operated MEWPs. Self-propelled machines are also tested at the maximum working angle **plus** 0.5° with a test load of 125% of the SWL. Finally, on all machines, a functional test is performed with 110% of SWL.

All safety devices are checked for correct operation, operating speeds are checked against benchmark figures and the dynamic functions ensure that all acceleration and deceleration forces are within acceptable limits. All noted defects are rectified and recorded before the machine is permitted to enter into service.

## **3 Preparation and Inspection**

### **3.1 UNPACKING**

Since the manufacturer has no direct control over the shipping or carriage of any Niftylift it is the responsibility of the dealer and/or owner and/or lessee to ensure the Niftylift has not been damaged in transit and a Pre-operational Report has been carried out by a qualified engineer before the aerial platform is put into service.

- 1) Remove all ropes, straps, and or chains used to secure the aerial platform during transit.
- 2) Ensure any ramp, loading dock or forklift used is capable of supporting or lifting the aerial platform.
- 3) If the aerial platform is to be driven off, please ensure that the operator has read and fully understood this entire manual. Refer to the appropriate section for precise operating instructions.

**\*\*Carry out the Pre-operational Report (Refer to Section 6.3) before placing machine in service.**

### **3.2 PREPARATION FOR USE**

Whilst every effort has been made at the Niftylift factory to ensure your machine arrives in a safe and operable condition it is necessary to carry out a systematic inspection prior to putting the aerial platform into service.



**THIS IS NOT A REQUEST IT IS MANDATORY**

To assist the user in this task you will find enclosed a Pre-operational Report, which must be filled out upon delivery/receipt of the machine.

Before the user carries out the Pre-operational Report he must have read and fully understood all the contents of the Operating, Safety and Maintenance Manual.



**WARNING - DO NOT OPERATE A POTENTIALLY DEFECTIVE OR MALFUNCTIONING MACHINE. CORRECT AND REPAIR ANY DEFECTS BEFORE OPERATING YOUR NIFTYLIFT.**



**MACHINE STABILITY** - The machine requires battery mass for stabilisation. If the batteries or any other significant component have been removed, **the machine will be unstable**. Contact Niftylift, UK before removal or replacement of any significant component.



### **3.3 PRE-OPERATIONAL SAFETY CHECK SCHEDULES**

Before use each day and at the beginning of each shift the aerial platform shall be given a visual inspection and functional test including, but not limited to, the following: It is recommended that these be performed at regular intervals as indicated on each checklist.

#### **3.3.1 DAILY SAFETY CHECKS**

- 1) Check that all labels (decals) are in place and legible
- 2) Visually inspect the machine for damaged or loose components.
- 3) Check that batteries are charged (Refer to Section 4.6 for further information).
- 4) Check the fuel level (if applicable).
- 5) Check that canopies/covers and guards are in place and secure.
- 6) Check that the boom inclination sensors are functioning correctly.
- 7) Check that control levers are secure and operate freely.
- 8) Check that operating buttons and emergency stop buttons function correctly.
- 9) Check the operation of the manual hand pump.
- 10) Visually inspect all hydraulic hoses and fittings for damage or leaks.
- 11) Check that the platform pivot pins and their tag bolts are secure.
- 12) Check that the tilt alarm is functioning correctly (On a slope of 3 degrees or more the alarm should sound and drive should be disabled).
- 13) Check the operation of SiOPS (Refer to Section 4.3.6).
- 14) Check the operation of the cage weigh system.

#### **3.3.2 WEEKLY SAFETY CHECKS**

- 1) Inspect tyres and wheels for damage and wear.
- 2) Check that the joystick manipulators are secure
- 3) Check hydraulic oil level, ISO Grade 22 (Europe), Grade 32 (Rest of World).
- 4) Check engine coolant level. **Caution**, the cooling system is pressurised, so allow engine to cool sufficiently before removing filler cap.
- 5) Inspect the engine air filter and clean or replace if necessary.
- 6) Inspect hose track for damage or missing parts.

## **Operating & Safety Instructions**

### **3.3.3 MONTHLY SAFETY CHECKS**

- 1) Check the engine oil level. Check wheel nuts are secured (torque 99ft lbs / 134Nm).
- 2) Check that the slew worm is secured and correctly in mesh. Clean and re-grease.
- 3) Check the track rod linkages.
- 4) Inspect brakes for operation and wear.
- 5) Inspect the engine fuel tank for damage or leaks.
- 6) Check telescopic boom wear pads and nylon studs (if applicable).
- 7) Every **Six** months perform a **thorough examination** in accordance with the 'Lifting Operation and Lifting Equipment Regulations' (LOLER) 1998, Regulation (9)(3)(a).

### **3.3.4 ANNUAL SAFETY CHECKS**

- 1) Check that all pivot pins and their tag bolts are secure.
- 2) Inspect for any cracks or badly rusted areas on booms and chassis.
- 3) Change the hydraulic oil filters.
- 4) Check the bushes in the front wheel hubs for wear.
- 5) Check that slew ring bolts are secure (torque 205ft lbs. 279Nm).

#### **Toughcage**

Niftylift **toughcage** is fully UV stabilised for outdoor use in the most demanding climates. However, the user and machine owner should consider the following;

- Discolouration of the material may occur; this is a natural aging process which does not significantly alter the material properties.
- Degredation to the floor may occur as a consequence of product use and effect of UV exposure. The **toughcage**'s multi-layer construction means degradation of the top surface may occur over time without compromising the structural strength of the internal and base layers.
- The rate at which the **toughcage** floor ages is dependent upon the machines application and its country of use (Typical levels of UV exposure). Refer to table below for aging rate applicable to your specific area.

UK, NETHERLANDS, GERMANY, POLAND, SCANDINAVIA, CANADA, RUSSIA	14 years
FRANCE, ITALY, USA (NORTH EAST STATES)	11 years
SPAIN, GREECE, TURKEY, CHINA, USA (MID WEST STATES), AUSTRALIA (TASMANIA)	9.5 years
MALAYSIA, INDONESIA	8 years

---

USA (SOUTH STATES), SOUTH AMERICA, AUSTRALIA (VICTORIA, NEW SOUTH WALES)	7.5 years
USA (WEST STATES), SOUTH AFRICA, INDIA, PAKISTAN, IRAN, AUSTRALIA (WESTERN, SOUTH, QUEENSLAND)	7 years
NORTH AFRICA, SAUDI, DUBAI, AUSTRALIA (NORTHERN TERRITORY)	6 years

**Note:** The date of manufacture of the **tough** cage floor is located on its underside.

Niftylift recommends that the user and machine owner **regularly** inspect the **tough** cage floor for damage. If any significant damage is found then the floor **must** be replaced. For further guidance please contact Niftylift Limited.

# **nifty** Height Rider/SP Series

## Operating & Safety Instructions

### 3.4 PLACARD, DECALS & INSTALLATION (UK SPEC)

ITEM	DESCRIPTION	NUMBER	QTY	
1	Serial Plate	P15383	1	
2	Cage Tie-down Warning	P21404	2	
3	Footswitch	P14884	1	
4	SWL 200kg	P30186	1	
5	Harness Point	P32302	2	
6	Cage Gate Warning	P18335	1	
7	Danger Warning - Text	P29380	1	
8	Danger Warning - Icons	P29379	1	
9	Clunk Click	P19961	1	
10	Caution - 'SiOPS'	P22820	1	
11	"If E-Stop Disabled	P14864	2	
12	'Do not place objects on controls'	P21511	1	
13	"Niftylift"	P30187	1	
14	Logo	HR12 SP34	P14604 P14119	2 2
15	General crush hazard	P14782	9	
16	Hydraulic levers – Base (on canopy)	P28482	1	
17	Operating Instructions	P14892	1	
18	Emergency controls location	P21700	1	
19	Daily Checks	P14908	1	
20	IPAF 'Are you trained?'	P22055	2	
22	No Step	P14785	2	
23	Battery Drain	P19850	1	
24	Isolator button	P26724	1	
25	Travel Direction	P29066	2	
26	Hydraulic Levers – Base	P29725	1	
27	Base Controls – Steer	P29723	1	
28	Manual Descent	P29668	1	
29	Gearbox Disengage	P18811	2	
30	Charger Socket	110V 230V	P26424 P26863	1 1
32	Point Load	(LE) 15.7kN (NE) 19.9kN	P31456 P31455	4 4
33	Lifting point	P14786	4	
34	Tie Down Points	P14958	4	
35	Hydraulic Oil	P14415	1	
	Low Temperature Bio Oil	P23622	1	
36	Pressurised tank	P16365	1	
38	Cage controls	P29438	1	
39	Base controls	P27597	1	
40	Joystick Steer	P29068	1	



**Operating & Safety Instructions**

**3.5 TORQUE REQUIREMENTS**

Bolt quality/size	Tightening torque in Nm (ft-lbs)					
	Plated			Unplated		
Grade	8.8	10.9	12.9	8.8	10.9	12.9
M6	7 (5)	10 (8)	12 (9)	8 (6)	11 (8)	13 (10)
M8	17 (13)	25 (18)	29 (22)	19 (14)	27 (20)	32 (23)
M10	34 (25)	49 (36)	58 (43)	37 (27)	54 (40)	63 (46)
M12	58 (43)	85 (63)	99 (73)	63 (47)	93 (69)	108 (80)
M14	93 (68)	135 (100)	158 (117)	101 (74)	148 (109)	172 (127)
M16	143 (106)	209 (154)	245 (180)	156 (115)	228 (168)	267 (197)
M20	288 (212)	408 (301)	477 (352)	304 (224)	445 (328)	521 (384)
M24	491 (362)	698 (515)	816 (602)	519 (383)	760 (561)	889 (656)
WHEEL NUTS	134 Nm (99ft lbs)					
SLEW RING BOLTS	279 Nm (205ft lbs)					

This torque chart is based on the following assumptions:

- 1) Bolts to ISO 898-1 "Mechanical properties of fasteners made of carbon steel and alloy steel"
- 2) For "unplated" bolts, all grades:
  - Hex head bolts
  - Black oxide steel bolt with a rolled & oiled thread, no finish on steel nut
  - Prevailing torque includes Nylock (minimum prevailing torque figure assumed)
  - Medium Clearance holes to ISO 273
  - Bolt tightening condition = Yield factor of 75%
- 3) For "plated" bolts, all grades:
  - Hex head bolts
  - Zinc plated oiled (rolled or cut) steel external thread with no finish on steel internal thread
  - Prevailing torque includes Nylock (minimum prevailing torque figure assumed)
  - Medium Clearance holes to ISO 273
  - Bolt tightening condition = Yield factor of 75%

Figures quoted in **Nm** have been calculated in Nm and then rounded to the nearest whole number. Figures quoted in **lb-ft** have been calculated in Nm, converted using a factor of 0.737561 and then rounded.

## 4 Operation

### 4.1 CONTROL CIRCUIT COMPONENTS

#### 4.1.1 GROUND CONTROLS

**PROGRAMMABLE LOGIC CONTROLLER (PLC):** - Situated behind the Ground Controls Station is the PLC. Its purpose is to receive signals from **all** areas of the control, to process the instructions and machine status, and to safely operate the relevant machine functions.

**TILT SENSOR:** - Installed on the superstructure behind the ground controls canopy, the tilt sensor monitors the inclination of the machine chassis. When the platform is in use, (i.e. Booms are raised), if the inclination exceeds the pre-set limit, it will disable all drive functions, sound the alarm and display a warning symbol on the screen. In order to recover the machine, boom operation is unaffected, allowing the operator to restore drive by lowering the booms into the stowed position. It is then possible to drive back onto level ground, fully restoring machine operation.

#### **MULTI-TONE SOUNDER AND BEACON**

The Niftylift will warn personnel that the machine is about to move when the green power button or footswitch is pressed. The machine's default setting is to sound a beeper at the base control location and flash a beacon mounted on the top of the engine canopy. However, the machine can be configured to select either the sounder or the beacon if site conditions require the machine to behave differently. (e.g. Beacon only, when used at night in a residential area). It is mandatory that one alert device is functioning, and it is not possible to turn off or permitted to disable both the beacon and sounder.

If a safety-critical situation occurs, the sounder will emit a "ricochet" sound to alert the user and nearby personnel. This warning occurs even if the motion sounder setting has been disabled.

**Cage Weigh:** - If the electronic load cell detects an overload condition, the machine will sound continuously in conjunction with the cage overload warning light and warning symbol on the screen display.

**HORN:** - Located on the side of the ground control box is a horn, which is used as a manual alert, by pushing the "Horn" button on the Platform Control Panel.

**BOOM SENSORS:** - Mounted inside the booms and operated by the raising of either boom, these sensors control both the operation of the Tilt Sensor, and the speed control function. With the booms in the stowed position, the Tilt Sensor is by-passed, allowing the machine to negotiate slopes in excess of the permissible elevated working angle, without isolating the drive function. At the same time, High Speed drive (Depicted by a Hare Icon) is possible. When the booms are raised the Tilt Sensor is activated and only Slow Speed drive is permitted. These control functions are of primary importance to safety of the machine and operator; **under no circumstances should this control function be isolated or by-passed.**

## **Operating & Safety Instructions**

### **4.1.2 PLATFORM**

**CAGE DISPLAY UNIT:** - Mounted in the Platform Control Station, this screen receives signals from the PLC to provide a warning indication to the operator for a range of functions. Refer to Section 4.3.2 for further details.

**LOAD SENSING CONSOLE (SiOPS™):** - This machine incorporates a load sensing console that senses if the operator has been pushed or has fallen against the console. If the load applied to the front of the console is greater than the pre-determined amount, the footswitch will be disabled to increase operator safety and reduce the possibility of sustained involuntary operation of the cage controls. For further information refer to Section 4.3.6.

### **4.1.3 FUSES**

#### **Chassis**

*Under **front** cover*

**250A** Fuse (isolator)

**Module Box 3 (NE)**

(Refer to HR12 MK2 Service Manual for fuse layout diagram)

*Under **rear** cover*

**125A x 3** Fuses on Drive control tray (Motor controllers)

**Module Box 2** (Drive control tray)

(Refer to HR12 MK2 Service Manual for fuse layout diagram)

**Module Box 3 (LE)** (Drive control tray)

(Refer to HR12 MK2 Service Manual for fuse layout diagram)

#### **Ground Control Station**

**Module Box 1**

(Refer to HR12 MK2 Service Manual for fuse layout diagram)

#### **Platform Control Station**

**5A** blade fuse behind Control Panel

**2 x 3A** blade fuses behind Control Panel



## 4.2 GROUND CONTROL OPERATION

### 4.2.1 GROUND CONTROL FUNCTIONS

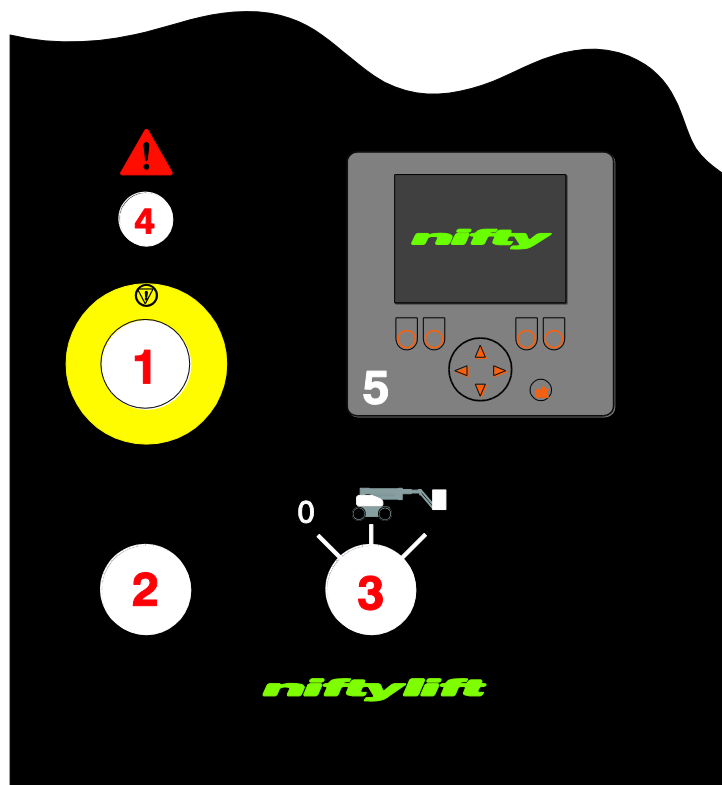

<b>1</b> Emergency Stop	Push to <b>Stop Operation</b>	Twist to <b>Enable Operation</b>
<b>2</b> Green Power Button	Push and hold for <b>Power</b>	Release to <b>Cease</b> operation
<b>3</b> Base/Platform Selector	<b>Clockwise</b> for Platform, <b>Centre</b> for Base, <b>0</b> for all power off	
<b>4</b> Status Lamp	<b>Red flashing:</b> Indicates safety critical problem. Refer to display screen <b>immediately</b>	
<b>5</b> Display Screen	See Section 4.3.2	

**Operating & Safety Instructions**

**Base Levers**

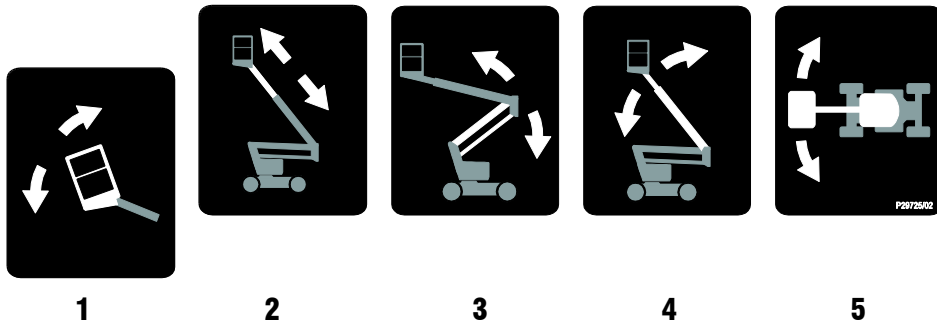

<b>1</b> Operates Platform Levelling	Forward for <b>Up</b>	Backward for <b>Down</b>
* <b>2</b> Operates Telescoping	Up for <b>Out</b>	Down for <b>In</b>
* <b>3</b> Operates the Lower Boom	Up for <b>Up</b>	Down for <b>Down</b>
* <b>4</b> Operates the Upper Boom	Up for <b>Up</b>	Down for <b>Down</b>
* <b>5</b> Operates Slew/Swing	Up for <b>Right</b>	Down for <b>Left</b>

\* **More than one function can be operated at the same time**

**4.2.2 OPERATION**

**ALL MODELS**

- 1) Check below, above and around the platform for any obstruction or hazards before operating any function.
- 2) Ensure all red emergency stops are out.
- 3) Turn key switch at ground control station to **Ground** (Single turn clockwise).
- 4) Push and hold green power button on the base control panel.
- 5) Select a function and operate the appropriate control lever(s) in full accordance with the manufacturers operating and safety manual. (Refer to Section 4.2.1)
- 6) To return control to the platform, turn base control key-switch to the **Platform** position (fully clockwise).
- 7) When not in use return machine to stowed position. Turn the base control key-switch anti-clockwise to the **OFF** position, remove key and chock wheels.

### **EMERGENCY PROCEDURES**

- 1) **Push in** red emergency stop to shut down **all** machine movement.
- 2) **Release** both emergency stops to restore normal controls.

In the event that the controls fail, the cage overload is activated due to contact with a fixed object or a cage operator is incapacitated, the booms can be operated from the base location as described below:

*If normal controls are available (fastest recovery time):*

- 1) Turn key switch to ground, press the green button and operate the desired function lever(s).

*If normal controls are **not** available:*

- 2) Locate the **manual hand pump** under the control side canopy.
- 3) Attach supplied handle to the hand pump.
- 4) Move and hold the desired boom function lever in the required direction.
- 5) Pump the hand pump to activate the selected function.
- 6) Release the lever and stop pumping to halt machine movement.
- 7) If recovering the machine because cage overload has deactivated the machine due to contact with a fixed object, then moving the machine slightly using steps 1-5 should be sufficient to re-enable normal operation. The cage overload alarm and visual warning will cease once normal controls are available.
- 8) If normal controls are still not available, continue pumping to lower the machine manually.

**Operating & Safety Instructions**

**4.3 PLATFORM CONTROL OPERATION**

**4.3.1 PLATFORM CONTROL FUNCTIONS**

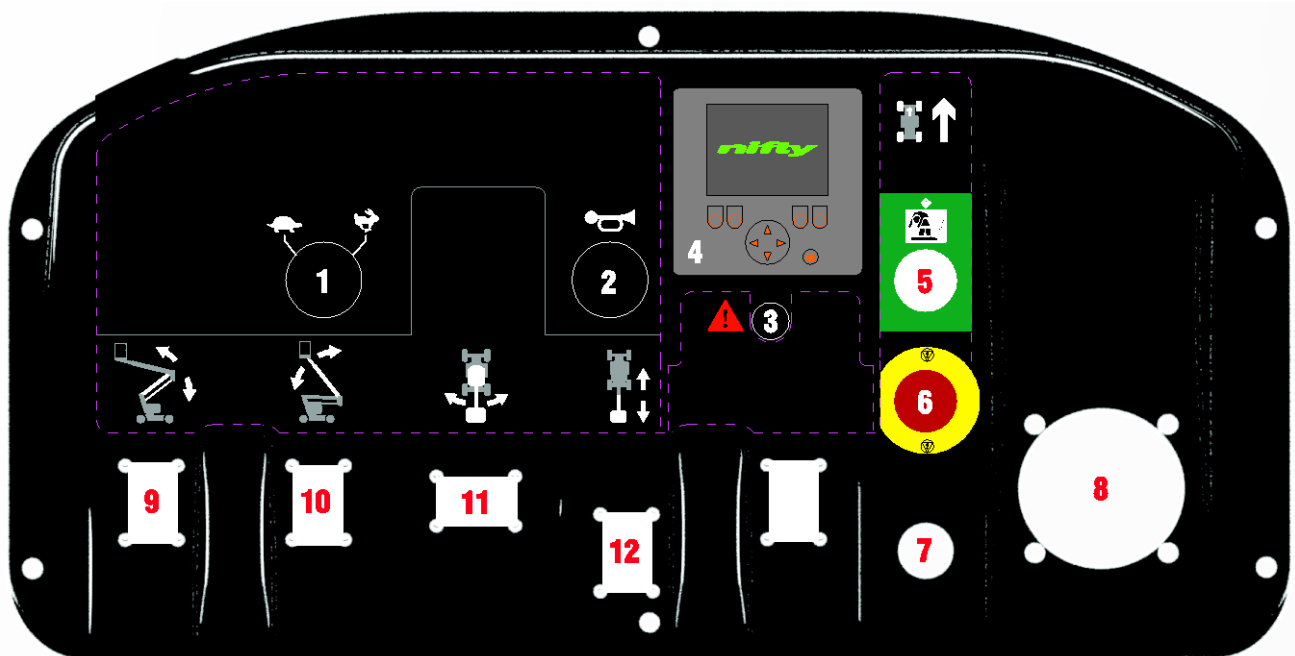

The platform controls are designed to prevent inadvertent operation of the machine and the user must be familiar with the following safety features.

- 1) **Footswitch timeout** – If the footswitch or green button is pressed, but no function is activated within 15 seconds, the machine will not function until the footswitch or green button is **released and re-pressed**.
- 2) **Controls neutral check** – If a boom control paddle or the drive joystick is moved from its neutral position **before** the green button or footswitch is pressed, that function will not be available until the control is returned to its neutral position and a deliberate action is taken to move the function **after** the green button or footswitch is pressed.
- 9) **Joystick Trigger timeout warning** – If the joystick trigger is pressed, but the machine is not driven within 30 seconds, then the machine will warn that the trigger has been held.

<b>1</b> Speed Selector	<b>Left</b> - Tortoise	<b>Right</b> - Hare
<b>2</b> Horn	Press & hold to <b>Sound</b>	
<b>3</b> Safety Warning Lamp	Indicates Safety Critical Problem (Refer to Display Screen <b>immediately</b> )	
<b>4</b> Display screen	See Section 4.3.2	
<b>5</b> Override Button	<b>Push</b> and hold to enable boom functions in the event of normal operation loss. (i.e. cage overload activated)	
<b>6</b> Emergency Stop	<b>Push</b> to Stop Operation	<b>Turn clockwise</b> to Release
<b>7</b> Green Power Button	<b>Push</b> and hold to activate machine	

**Operating & Safety Instructions**

<b>8</b> Joystick	Grip the joystick and hold the trigger switch at the front. Machine movement is achieved by slowly moving the joystick away from the neutral position in the required direction. Steer by using the thumb rocker switch located on top of the joystick.	
* <b>9</b> Operates Lower Boom	Up for <b>Up</b>	Down for <b>Down</b>
* <b>10</b> Operates Upper Boom	Up for <b>Up</b>	Down for <b>Down</b>
* <b>11</b> Operates Swing	Left for <b>Left</b>	Right for <b>Right</b>
* <b>12</b> Operates Telescoping	Up for <b>Tele-In</b>	Down for <b>Tele-Out</b>

\* **More than one function can be operated at the same time**

**4.3.2 DISPLAY SCREEN**

Situated on the Ground and Cage Control Panels, this gauge provides operational and/or a warning indication for a range of functions. For further information refer to Section 4.3.3 'Information Icons' on Page 28 or Section 4.3.4 'Menu Screens' on page 30. During machine operation the gauge displays current battery level, cage load status and current boom/drive speed setting.

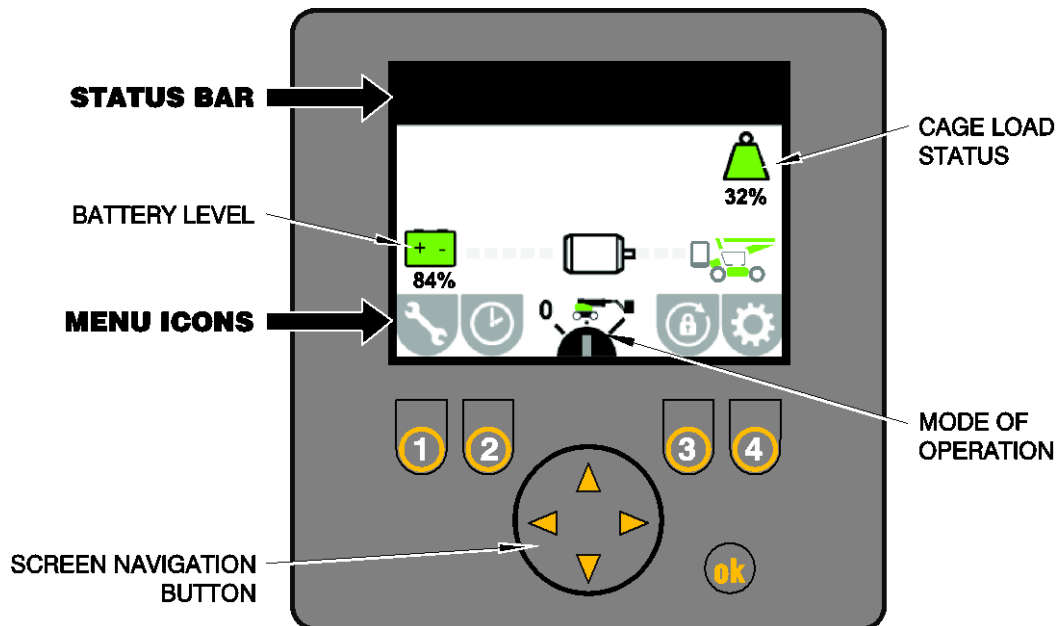

If the control system detects a malfunction on the machine one or more of the icons in the **status bar** will illuminate. Please refer to Section 4.3.3 for further info.

## Operating & Safety Instructions

### 4.3.3 INFORMATION ICONS

#### Safety Critical (Main screen)



**MAX tilt angle exceeded:-** The alarm sounds, the display shows this image and drive is disabled. Lower booms down into the stowed position and drive onto level ground to fully restore machine operation.



**Safe Working Load (SWL) exceeded:-** The alarm sounds and the display will show this image. The Maximum SWL (200kg/500lbs) has been exceeded. Immediately remove any unnecessary items from the platform **in a safe manner** to restore machine functions.

Alternatively, the platform may have come into contact with a fixed object, see Section 4.3.5 for recovery procedure.

Note: If a **Safety Critical** condition has been detected, the safety warning lamp on the Platform Control Panel and Base Control Panel will also illuminate.

#### Advisory (Main screen)



**Release E-Stop:-** Machine will not operate as one or both of the Emergency Stop buttons are pressed. Twist and release to restore normal controls.



**Footswitch Timeout:-** Machine will not operate. Release and re-press footswitch or green button to restore normal controls (Refer to Section 4.3.1).



**Controls Neutral:-** Boom control paddle or drive joystick has moved from the neutral position **before** the green button or footswitch was pressed. Return to neutral position and move **after** green button or footswitch has been pressed (Refer to Section 4.3.1).



**Joystick Timeout:-** Machine drive will not operate. Release and re-press trigger to restore normal controls (Refer to Section 4.3.1).



**Charge Batteries:-** Machine batteries require immediate recharge. Refer to Section 4.6.

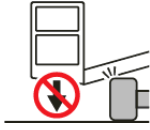

**Anti-clash active:-** to avoid potential machine damage, boom lowering and slew functions have been disabled due to minimum height from ground being reached. Raise boom until symbol disappears from screen to restore all control functions.



**SiOPS:-** SiOPS has been activated, to restore normal machine controls refer to Section 4.3.6.

**Advisory (Mode of operation)**



**Drive/Function Speed:** Determined by the Speed Selector switch on the Platform Control Panel (Refer to Page 26). Digital display reverts to these icons once the joystick trigger is activated.

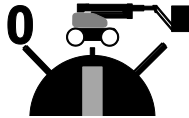

**Ground Controls:** To enable **platform** controls, selector switch located on ground controls must be turned clockwise (Refer to Section 4.2.1, Item 3).



**Auxiliary:** Auxiliary power is in use.



**Drive Disabled:** Drive function has been disabled due to a safety critical condition. To restore drive, refer to Safety Critical Section on Page 28.

**Status Bar**

If icons on the status bar are 'greyed out' this indicates normal operation.



**Electric Motor**

**Amber:** Warning, motor on reduced power.

**Red:** Communication Error detected.

Press **Button 1** for further information.



**Tilt Warning**

**Red:** Max tilt angle exceeded.

(Refer to 'Safety Critical (Main screen)' section on page 28).

## Operating & Safety Instructions



### Cage Overload Warning

**Red:** SWL exceeded.  
(Refer to 'Safety Critical (Main screen)' section on page 28).



### Cage Overload Override Evidence

**Amber:** Cage overload has been overridden.  
This will remain until reset.



In order to reset overload override evidence, press **Button 3** and follow on-screen instructions.



### General Error

**Amber:** General error.

**Red:** Critical error.

Press **Button 1** for further information.



## 4.3.4 MENU SCREENS

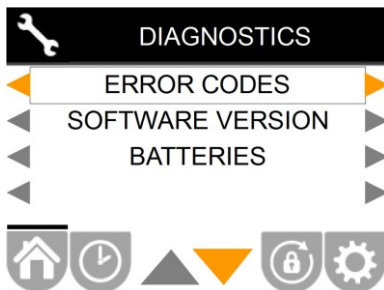

### DIAGNOSTICS



To access this screen, press button **1**.

This displays options to access **Error Codes, Software Version and Batteries** information.

Scroll up or down to the information required using the arrow keys and press the right arrow key or **ok** to open the screen. Press Left arrow key or button **1** to return to previous screen



### Error Codes

If the control system detects a malfunction on the machine, an error code will be displayed. For further information refer to **Appendix A**, or the HR12 MK2 Service Manual.



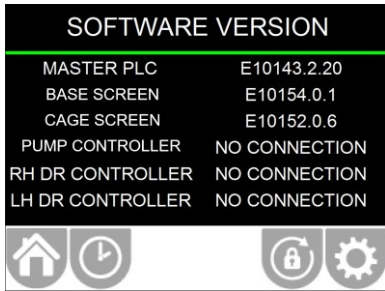

**Software Version**

Displays a list of the programmable devices installed on the machine and the software version for each device.

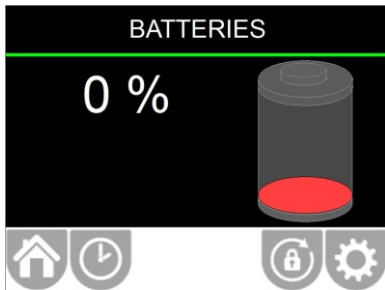

**Batteries**

The screen displays the battery charge status. **Green** indicates normal power is available, **yellow** indicates a reduced power state and **red** indicates a critical power level.

It will appear automatically with this symbol if the machine is on charge, to warn any potential operators to disconnect the charger before use.

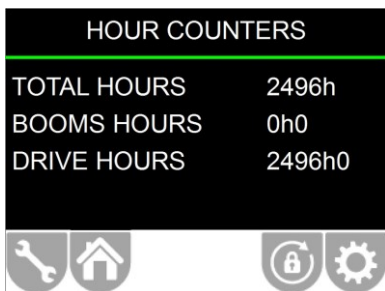

**MACHINE HOURS**



To access this screen, press button **2**.

Total Hours, Booms Hours and Drive Hours are displayed.

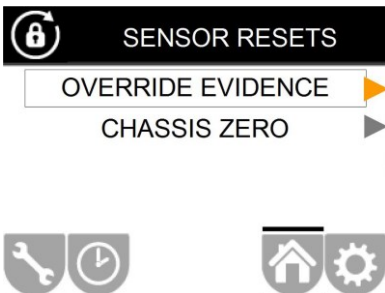

**SENSOR RESETS**



To access this screen, press button **3**.

To reset either the Cage overload override evidence or Chassis zero contact Niftylift using the details displayed and quote the reference number displayed on the screen.



Niftylift will supply a code which must be entered by using the arrow keys.

**Note:** The machine **must** be in the stowed position when entering the code.



## Operating & Safety Instructions



### SETTINGS



To access this screen, press button **4**.

Beacon/Sounder and Machine Info options are displayed.

Scroll up or down to the information required using the arrow keys and press the right arrow key or **ok** to open the screen. Press Left arrow key or button **4** to return to previous screen.

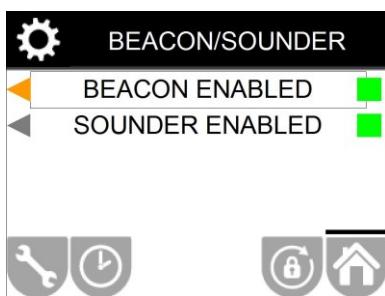

### Beacon/Sounder

This allows the operator to select between the beacon or sounder for a motion alert.

Note: Either the Beacon or Sounder **MUST** be enabled; the system will automatically select one if the operator attempts to deselect both.



### Machine Info

This displays information specific to the individual machine.

Serial Number, Power Type, Region and Model.

#### 4.3.5 OPERATION



**BEFORE OPERATING THE NIFTYLIFT ENSURE THAT EACH OPERATOR HAS READ AND FULLY UNDERSTOOD THE OPERATING MANUAL. FAILURE TO DO SO MAY RESULT IN DEATH OR SERIOUS INJURY.**

##### ALL MODELS

- 1) **NEVER** exceed the maximum platform capacity.
- 2) Check below, above and around the platform for any obstruction or hazards before operating any function.
- 3) Ensure all red emergency stops are out.
- 4) Turn key switch at ground control station to **Platform** (fully clockwise).
- 5) Depress the footswitch or push and hold green power button on the platform control panel.
- 6) Select one or more functions and operate the appropriate proportional paddles (levers) in full accordance with manufacturers operating and safety manual.
- 7) To return control to the base, turn the base control key-switch to the **Base** position (centre).
- 8) When not in use return booms to the stowed position. Turn key switch on the ground control station to the fully anti-clockwise **OFF** position, remove key and chock wheels.



**ALWAYS ENSURE THE AERIAL PLATFORM IS ON A FIRM LEVEL SURFACE AND THE AREA IS FREE OF ANY OVERHEAD OBSTRUCTIONS.**

**ENGAGING THE RED EMERGENCY STOP BUTTON WILL SHUT DOWN THE ELECTRIC CIRCUIT, PREVENTING OPERATION OF ANY FUNCTION.**

##### EMERGENCY PROCEDURES

- 1) Push in red emergency stop to shut down **all** machine movement.
- 2) **Release** both emergency stops to restore normal controls.

In the event that the controls fail or the cage overload is activated as described in Section 5.3, the booms can be operated from the cage location as described below:

- 1) Press **white override button** situated on the cage console. (Refer to Section 4.3.1)
- 2) Activate a single desired function paddle.  
(Note: Multiple boom function is not available in override mode).
- 3) If the cage has contacted a fixed object and cage overload has disabled the machine, move machine slightly using steps 1-2. The overload alarm and visual warning will cease and normal controls are available.
- 4) Use normal controls if available for the fastest recovery time. Press the green button or footswitch and operate the desired function lever(s).

### **Operating & Safety Instructions**

- 5) If normal controls are not available, continue using the override button to lower the machine using auxiliary power.

**Note:** The override mode is for **booms only** and will not operate the drive function.

#### **4.3.6 SiOPS™ - LOAD SENSING CONSOLE**



**WHEN OPERATING THIS MACHINE THE USER MUST BE AWARE OF ANY OVERHEAD OBSTRUCTIONS.**

This machine incorporates a load sensing cage console that senses if the operator has been pushed or has fallen against the console. If the load applied to the front of the console is greater than the pre-determined amount, the footswitch will be disabled to increase operator safety and reduce the possibility of sustained involuntary operation of the cage controls.

**Note:** The green button will illuminate once the footswitch has been disabled, but continues to be available for use at all times. This allows the operator to use the cage control functions and manoeuvre the machine to a safe position. If cage overload has also activated, the procedure described in Section 4.3.4, 'Emergency Procedures' (above) should be followed first.

To reset the footswitch and normal controls:

- 1) Release the load from the front of the console.
- 2) Ensure cage controls are in the neutral position and clear of objects
- 3) Raise foot clear of footswitch then lower foot onto footswitch to reactivate.

**Note:** If SiOPS™ has been activated and the footswitch is not reset within **15 seconds**, then the blue warning beacon will flash (located on underside of the cage) and a warning announcement will sound until the footswitch is reset as described previously.

## 4.4 DRIVING CONTROLS



**DO NOT OPERATE THE NIFTYLIFT WHILST ELEVATED UNLESS ON A FIRM, LEVEL SURFACE FREE FROM ANY POSSIBLE OBSTRUCTIONS OR HAZARDS BOTH AT GROUND LEVEL AND OVERHEAD.**

- 1) Check proposed route for possible hazards, obstructions and personnel.
- 2) Depress footswitch located on platform floor.
- 3) Set the **speed selector** switch on the platform control station as required.

**Tortoise** (Low Speed) - gives low speed and high gradeability.

**Hare** (High Speed) - gives high speed and low gradeability.

Note: High Drive Speed (Hare) is only available when the booms are in the stowed position. **The HR12 will default to Elevated Drive speed whenever the booms are elevated.**

- 4) Select drive joystick from the platform control panel.

Push forward for **FORWARD DRIVE**

Pull backwards for **REVERSE DRIVE**

Steering is controlled by the rocker-switch button on the top of the joystick

Left for **STEER LEFT**

Right for **STEER RIGHT**

The driving horn is activated by a button on the platform controls (Refer to Section 4.3.1).

All control levers give a fully proportional response therefore the more the lever is moved away from the centre **off** position the faster the function will become.

When driving with the booms fully stowed, the Tilt Sensor is bypassed to allow the Niftylift to be driven in areas where the slope exceeds the allowable inclination limit. In normal operation the drive is therefore unaffected when driven onto a slope in excess of this limit, until the booms are raised, whereupon the drive is disabled and the tilt alarm sounds continuously.

Under no circumstances should any SP series machine be driven on slopes **exceeding 25%** with the booms fully stowed.



**ALL NIFTYLIFTS HAVE A TILT ALARM INSTALLED - PRE-SET IN THE FACTORY. ONCE ENERGISED, THE NIFTYLIFT WILL LOSE ALL POWER TO DRIVE FUNCTIONS AND A LOUD AUDIBLE ALARM WILL BE ACTIVATED.**

**TO DE-ACTIVATE, LOWER THE BOOMS FULLY TO THEIR STOWED POSITION AND RE-POSITION BASE ON FIRM, LEVEL GROUND.**

**IF ALARM SOUNDS - DESCEND IMMEDIATELY AND RE-LEVEL MACHINE BASE.**

## **Operating & Safety Instructions**

### **4.5 CAGE WEIGH SYSTEM**

#### **4.5.1 LOAD CELL VERSION**

The Niftylift HR12 is fitted with an electronic load cell. This load cell is a moment-independent design. This means that independent of the load position inside the machine cage, the actual load is measured and if pre-calibrated limit values are exceeded, warnings will be activated. If load exceeds the safe working limit (SWL) of the machine, the machine will be disabled until the load is reduced to below 95% of the safe working limit. The design of the unit meets the requirements of both BS EN 280 and ISO 13849 with a safety integrity level of "Category 3 PL d. (Refer to Appendix A)

The current load in the cage is displayed on the digital display unit as a percentage of SWL. Please refer to Section 4.3.2.

#### **4.5.2 CALIBRATION, INSPECTION AND MAINTENANCE**

Calibration, maintenance and repair of the Niftylift HR12 cage load cell requires specialist knowledge and equipment. **For this reason, no part of the Niftylift HR12 cage-weigh system can be adjusted, repaired or inspected by the operator.**

All enquiries relating to calibration, inspection or maintenance should be directed to Niftylift or one of their approved dealers. Contact details are listed in Section 1.3.

## 4.6 BATTERIES AND CHARGING



**BATTERIES MUST BE RECHARGED IN A WELL-VENTILATED AREA FREE OF FLAME, SPARKS OR OTHER HAZARDS THAT MAY CAUSE EXPLOSION. HIGHLY EXPLOSIVE HYDROGEN GAS IS PRODUCED DURING THE CHARGING PROCESS. NEVER ATTEMPT TO CHARGE A FROZEN OR NON-RECHARGEABLE BATTERY.**

- 1) Recharge batteries at the end of every working day or shift.  
(**Note:** To recharge batteries fully from flat takes approx. 12 hours, this consists of 8 hours bulk charging plus 4 hours equalisation).
- 2) Plug charger into a suitable power supply, either 240 volts or 110 volts AC (see **Charging Limitations**, Page 41). (Note: If using 240V, use of a suitably rated Earth Leakage Circuit Breaker (ELCB) or Residual Current Device (RCD) at the point of supply is highly recommended.)
- 3) Take note of the indicator provided on the base:  
**Green lamp (Fast flash)**- Batteries are charging.  
**Green lamp (Slow flash)** - Batteries are charging and between 80% & 100% capacity.  
**Green lamp (Static)** - the batteries are fully charged.  
**Red lamp flashing** – Fault (see 'Charging Limitations').
- 4) The charger will automatically switch off once the batteries are fully charged. It is recommended to reconnect the charger to a suitable power supply when the machine is not in use to maintain good battery condition. Charger will monitor and maintain correct battery charge level.



**UNDER NO CIRCUMSTANCES SHOULD A MACHINE BE LEFT FULLY DISCHARGED AS SEVERE BATTERY DAMAGE CAN OCCUR IN A RELATIVELY SHORT TIME.**

- 5) The machine boom functions can be used whilst on charge. **Do not drive** machine to avoid damage to cables etc. To disconnect charger, firstly switch off the power supply. Ensure LEDs are **off** before disconnecting the charger from the power supply.

### Notes:

- 1) If the charger is reconnected to the power supply shortly after it has gone through its full charging cycle, the base will show the Green, fast flash lamp, immediately followed by the Green, slow flash lamp. The charger would then go through its complete cycle again at an accelerated rate, depending on the time difference between connection, reconnection, and level of battery charge.

## Operating & Safety Instructions

### CHARGING LIMITATIONS

The capacity of the 110V supply must be capable of 3.5kVA (32A current); hence a small hand-tool transformer must **not** be used with the battery charger. A minimum size of 4.5kVA is highly recommended.

**Note;** charger output will fall if air temperature is below 0°C or above 50°C.

### Fault Conditions

If a fault occurs, count number of flashes between pauses and refer to table:

Red LED status	Cause	Solution
<b>One</b> flash	Battery High Voltage	Check battery size and condition. This fault will automatically clear once the condition has been corrected.
<b>Two</b> flashes	Battery Low Voltage	Check battery size and condition. This fault will automatically clear once the condition has been corrected.
<b>Three</b> flashes	Charger Timeout. Caused by battery pack not reaching required voltage.  Charger output reduced due to high ambient temperature.	Check connections.  Operate charger at a lower ambient temperature.  Reset charger (interrupt AC power for 15 seconds)
<b>Four</b> flashes	Check Battery(ies); battery could not be trickle charged up to minimum voltage.	Check for shorted or damaged cells  Reset charger (interrupt AC power for 15 seconds)
<b>Five</b> flashes	High temperature. Charger shut down due to high internal temperature.	Ensure sufficient cooling airflow and reset charger (interrupt AC power for 15 seconds)
<b>Six</b> flashes	Charger Internal Fault	Reset charger (interrupt AC power for 15 seconds). Return to service department if fault persists.



**DURING CHARGING, THE CHARGER SURFACE MAY BECOME HOT ESPECIALLY IN HIGHER AMBIENT TEMPERATURES. THIS IS NORMAL.**

Attention should also be given to the use of extension cables as power leads. Excessive cable lengths from the supply point to the battery charger will result in significant voltage drop, leading to a reduction in the chargers efficiency. In addition, inadequate sized cable cores will have a limiting effect on its current carrying capacity, which will again lead to a reduction in the chargers efficiency. Both of these can result in over-heating of the cable with an increased risk of fire, short circuits, or damage to the components themselves. . A minimum core size of 4mm<sup>2</sup> is recommended and lengths in excess of 50m must be avoided. Extension cables must have appropriate safety approvals for the country in which it is used.



**Operating & Safety Instructions**

The charger requires a minimum battery voltage of 1.5 volts per battery (overall for two batteries 3 volts, for 4 batteries 6 volts for 8 batteries 12 volts and 18V for 72V). If the voltage is below these values then the charger will not function (Charger will not detect batteries to begin charge.) If the batteries have fallen to such a poor state they will have to be removed from the machine and charged individually with an independent charger until the optimum voltage has been reached. This is best performed at very low currents to 'recover' the batteries if sulphation has already started i.e. a 'trickle' charger. This can take several hours, possibly days. Careful monitoring of the rise of battery voltage will indicate when recovery has been achieved.

**TOPPING UP**

The batteries installed on this machine are Maintenance Free. **DO NOT ATTEMPT TO REFILL** or irreparable damage will occur.

**Operating & Safety Instructions**

**4.7 TRANSPORTING, TOWING, CRANEAGE, STORAGE AND SETTING TO WORK**

**4.7.1 TRANSPORTING**

If a work platform is to be moved over a longer distance, whether the machine is trailer mounted, vehicle mounted, self-propelled or tracked, the following procedure should be read before restraints are attached to the machine. Cross loading is most frequently the cause of problems, as the method of loading is no longer in sight of our own personnel. The recommendations made herein should be passed on to subsequent carriers, such that the entire journey is carried out without incident.

- Always ensure the truck or trailer you are loading or towing the Niftylift with can carry it legally.
- If loading by crane the use of shackles and an adequately rated spreader beam, with four leg slings, is **MANDATORY**.
- When loading or un-loading from the side of the vehicle, the use of the forklift pockets to retain one of the forks is recommended. (If fitted). Spread the forks to their widest capacity, with due regard to the components fitted to the machine. Never forklift or crane an entire machine under the booms, always lift beneath the spine or under the ends of the axle mountings in the case of a self-propelled unit. Ensure forklift is adequately rated for the load to be carried.
- Once positioned on the transport carrier ratchet straps should be used to secure the machine. The machine should be positioned to allow easy access around the machine in transit, and to ensure that 'creepage' during transport does not permit the machine to come into contact with other goods being shipped, or the container itself. Some movement of the machine structure might occur during transit, which could lead to fretting or other damage.
- If the machine is equipped with a transit device such as a boom clamp etc, this should be securely applied.
- Strap booms carefully to constrain them from sideways movement. When using straps or chains, adequate packing should be applied to stop any damage to the structure and paintwork. Due regard of the movement of the straps or chains must be taken into account.
- Where a machine has designated points for strapping, lifting or forking, these can be used for tie-down duty. When they are absent, the major structure of the platform can be used, giving due consideration to the design and function of the area chosen. Where possible, use the spine of the machine or axle mounts over which to apply the holding down forces. Using a single plate, such as an outrigger or stabiliser support plate might be unsuitable. Only apply transport straps to the marked anchor points on the machine.
- Under no circumstances should straps or chains be applied over booms or through the cage support structure or the cage itself. The relative strength of the carrying structure is not conducive to the massive forces capable of being applied through ratchet chains or slings. Severe damage to the steelwork can be caused, as well as deformation to sensitive mechanisms such as cage weigh assemblies, which would render them useless. Such catastrophic damage to say, an electronic load cell would require the component to be replaced before the machine would function.

## 4.7.2 TOWING

To enable towing of the HR12 **2x4** in case of an emergency.

### GEARBOX DISENGAGEMENT

The drive gearboxes located on the front and rear wheel hubs must be disengaged as follows;

- 1) To disengage the gearbox, remove both screws from the cover plate, turn it upside down (as per the diagram below), and re-tighten the M5 screws to a torque of 5 Nm (3.7lbf).
- 2) Before attempting to re-engage the gearbox, ensure that the machine is jacked up so the relevant wheel is clear of the ground in order to prevent damage. **Note; Damage caused by failure to comply with this notice will not be covered by the manufacturer's warranty.**

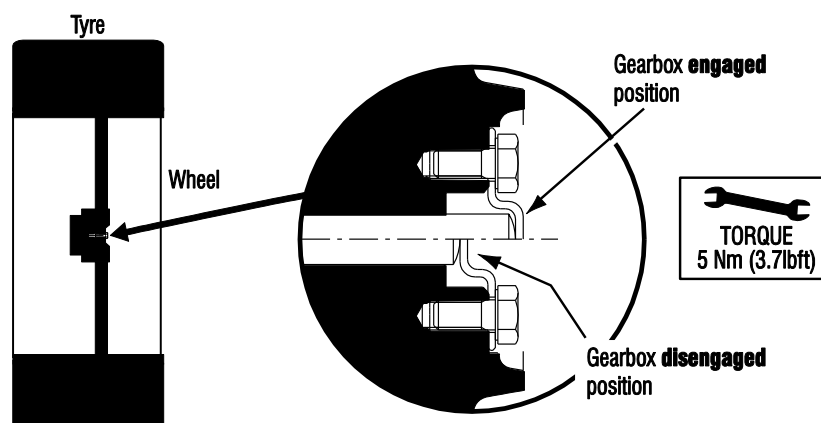

## 4.7.3 CRANEAGE

- 1) Observe all of the limitations relating to straps and chains stated above under 'Transporting'. (4.7.1)
- 2) When utilising the designated lifting points never apply a 'snatch' load, i.e. lift slowly to take up the load before raising. Similarly, do not drop machine when positioning after lifting.
- 3) If the machine is to be lifted by crane, use the designated lifting points and observe the recommendations regarding spreader beams. Individual drawings are available for each machine type, on request. (See list below.)

D81790  
D81795  
**D81996**  
**D82069**

HR15/17 4x4/Hybrid MK2  
HR15N/17N  
**HR12NE MK2**  
**HR12LE MK2**

## 4.7.4 STORAGE

If being stored for any length of time without use, then the machine should be thoroughly inspected for the following:-

- 1) Grease all bearings /slides, worm drives, etc.

## **Operating & Safety Instructions**

- 2) Check batteries for state of charge, damage, dirt, etc. Ensure batteries are **fully charged** before storage. If no use of the platform is intended, an occasional "top-up" charge of the batteries will serve to equalise their charge level. **Never leave in a state of discharge for any length of time.** Refer to HR12 MK2 Service Manual for further information.
- 3) Leave battery disconnect switch in **OFF** position to prevent discharge of batteries through leakage.
- 4) If machine is to be left on an incline, chock wheels to prevent creep.
- 5) If machine is to be left outside or in a hostile environment, cover with suitable weatherproof media to prevent deterioration.

### **4.7.5 SETTING TO WORK**

Before use each day and at the beginning of each shift the machine shall be given a visual and functional test including, but not limited to, the following

- 1) Check all lubrication points for adequate application of grease, oil etc.
- 2) Inspect all threads for ease of operation - especially descent valves, brake release valve etc.
- 3) Check level and quantity of oil. Remove any contaminants - water, etc.
- 4) Check batteries for electrolyte and state of charge.
- 5) Check electrics for damage and insulation.
- 6) Using ground controls, cycle machine over complete envelope in accordance with the Operating Instructions. Cure any defects.
- 7) Ensure that all safety devices and controls operate in accordance with the instructions.
- 8) If necessary, perform a load test to establish the machine stability before putting the machine to work.
- 9) On completion of an extended period of road transport, the machine might need additional inspection to identify any transit degradation, which could render the machine unsafe. Perform a Pre-delivery Inspection on the unit before it enters service. Record any faults found and rectify them immediately.
- 10) If left un-attended for an extended period, it is likely that the hydraulic cage levelling will become un-pressurised. Normal operation is then lost, with a noticeable delay in the forwards or backwards motion as the booms move. To restore normal function, operate the cage-levelling function at the Ground Control Station, the cage needs to be fully levelled forwards and backwards. When the system has been charged in both directions, the cage levelling function should be restored. Repeat the procedure as described above until the movements are smooth and un-interrupted. If in doubt, contact our Service Department for further advice.

Niftylift Limited is not liable for any third party damage caused during transport. Careful attention to correct procedures will prevent many of the small snags that can happen in transit. Re-work is both expensive and time consuming. A defective machine arriving at the place of work is a poor advertisement for our product, the company's reputation and those of our dealers and clients. The responsibility for safe and damage-free transport rests with the haulier or their representatives.

## 5 Emergency Controls

### 5.1 GENERAL

**CHECKING THE OPERATION OF THE EMERGENCY CONTROLS EVERY DAY AND/OR BEFORE EACH SHIFT IS AN ESSENTIAL PART OF THE OPERATOR'S DUTIES**



The operator and all ground personnel must be thoroughly familiar with the location and operation of the emergency controls.

### 5.2 IN THE EVENT OF AN INCAPACITATED OPERATOR

Turn the key switch at the ground control station to **ground** (central position).  
Manoeuvre the machine using the ground controls as described previously in Section 4.2.

### 5.3 IN THE EVENT OF MACHINE FAILURE

If all machine power is lost, the **manual hand pump** can be used to provide the hydraulic power to manoeuvre the machine. If initial movement of the machine allows the master alarm to reset, normal controls will be available. This is then the fastest method of lowering the platform to the ground.

**Note:** If the machine is fitted with a cage overload system, and the cage comes into contact with a fixed object whilst operating at height, this would be detected as an overload condition. All power to the machine controls would be lost, requiring the machine to be recovered using the **Manual Hand Pump** or **Auxiliary Descent Pump**. It is sufficient for the cage to be manoeuvred away from the collision point to re-set the cage weigh mechanism, thereby restoring normal machine operation. The cage can now be lowered using the controls as described previously in Section 4.3.

**FOLLOWING AN EMERGENCY DESCENT RECOVERY OF THE PLATFORM, FULLY EXTEND AND RETRACT ALL CYLINDERS FROM GROUND CONTROL STATION BEFORE USING THE MACHINE.**



### 5.4 INCIDENT NOTIFICATION

It is a mandatory requirement that any accident or incident involving a Niftylift, regardless of whether any party received injury or property was damaged is reported by telephone directly to Niftylift. Failure to do so may render any warranty on the machine void.

## **6 Responsibilities**

### **6.1 CHANGES IN OWNERSHIP**

When a change of ownership of a Niftylift occurs, it shall be the responsibility of the seller to notify Niftylift directly of the unit, model and serial number and the name and address of the new owner within 60 days. This important step is required so that any relevant Technical Bulletins are able to reach the registered owner of each machine without delay. Please note warranties are not transferable.

### **6.2 MANUAL OF RESPONSIBILITIES (USA only)**

You are required by ANSI/SIA 92.5 2006, to read and understand your responsibilities before you use or operate this aerial platform. Please read the enclosed document, as failure to do so could result in death or serious injury. Wherever any contradiction may appear, the Manual of Responsibilities shall take precedence over all other documents.

**6.3 INSPECTION/SERVICE/PRE-HIRE CHECK LIST**

**MACHINE SERIAL NO** \_\_\_\_\_

<b>ADMINISTRATION</b>	<b>PASS</b>	<b>FAIL</b>	
Daily, Weekly, Monthly checks carried out as outlined in manufacturers Operating and Safety Manual?			
Machine has valid LOLER Certificate? (UK only)			
<b>TOWING</b>	<b>PASS</b>	<b>FAIL</b>	<b>N/A</b>
Check brakes are released or...			
Check wheel gearboxes disengage when required			
<b>AXLES, WHEELS AND BRAKES</b>			
Axles are secure			
Wheels are secure, tyre condition acceptable			
Wheel alignment and tracking correct			
Tyre pressure correct			
Wheel nut torque correct			
Operation of front and rear steer functions			
Operation of suspension dampers (if applicable)			
Pivot pins and swing bolts secure			
<b>BASE</b>			
Operation of Emergency Stop button			
Operation of Base control valve and buttons			
Operation of all booms over full range			
Platform maintains level over full range			
Hoses not tight, kinked or fouled			
Operation of manual hand pump			
Operation of auxiliary descent pump			
Operation of tilt sensor when driven elevated on slope > 3°			
Pivot pins and swing bolts secure			
<b>BOOMS</b>			
Inspect for damaged, distorted or loose components			
Wear pads present and secure			
Cylinders are silent and not fouling during operation			
Cylinders do not drift when machine is switched off			
Operation of inclination sensors			
Chain inspection - Correctly tensioned, damage etc.			
Energy chain correct and secure over tele function range			
Bushes (Condition check)			
Pivot pins and swing bolts secure			

# **nifty** Height Rider/SP Series

## Operating & Safety Instructions

<b>PLATFORM</b>	<b>PASS</b>	<b>FAIL</b>	<b>N/A</b>
Operation of Emergency Stop button			
Operation of SiOPS (Refer to Section 4.3.5)			
Operation of control valve and control panel buttons/switches			
Operation of all booms over full range			
Operation of Footswitch			
Platform levelling over full range			
Slewing smooth over full range			
Condition of harness points			
Condition and operation of entry/exit drop gate			
<b>POWER SYSTEM</b>			
Engine - Refer to Pre-Operation and Maintenance sections in engine manufacturers Operating Manual as supplied			
All cables and terminals secure			
All hose connections secure			
Charger/control box secure			
Battery secure			
Hydraulic oil level			
<b>SLEWING</b>			
Slew gearbox and motor are secure			
Slew wheel bolts secured			
Slew guards secure			
<b>FINISH</b>			
Serial plate against documentation			
Check all decals in place and legible			
Canopies in place and secure			
Check all guards are in place and in good condition			
Grease nipples (Slew ring, Steer pins)			
<b>LEAK CHECK</b>			
Hydraulic Cylinders (Lift, Telescope, Levelling)			
Control valves			
Check valves			
Power system pump			
Filters			
Hand pump			
Slew motor			
Hydraulic Hose connections and fittings			

**Note; Environmental factors and usage amount will affect the type of checks and also the frequency of inspection intervals.**



***nifty* Height Rider/SP Series**  
**Operating & Safety Instructions**

---

**Comments, remedial work required etc;**

**INSPECTED BY:** \_\_\_\_\_

**DATE:**    /    /

# Appendix A

## Application specific error codes

For more comprehensive error information please refer to the HR12 MK2 Service Manual.

<b>Error Code</b>	<b>Description</b>	<b>Action</b>
<b>019F0000</b>	The Steer Sensor is out of range	Contact a Niftylift approved service centre
<b>01A00000</b>	There is a problem with the signals from the normally closed and normally open contacts of SiOPS to the PLC	Ensure contact blocks are securely in position. Check SiOPS wiring from the switch contacts to the PLC
<b>01A10000</b>	There is a problem with the signals from the normally closed and normally open contacts of the Keyswitch to the PLC	Ensure contact blocks are securely in position. Check Keyswitch wiring from the switch contacts to the PLC
<b>01A20000</b>	There is a problem with the signals from the normally closed and normally open contacts of the Base E-Stop to the PLC	Ensure contact blocks are securely in position. Check Base E-Stop wiring from the switch contacts to the PLC
<b>01A30000</b>	There is a problem with the signals from the normally closed and normally open contacts of the Cage E-Stop to the PLC	Ensure contact blocks are securely in position. Check Cage E-Stop wiring from the switch contacts to the PLC
<b>01A40000</b>	There is an error with the signals from the Load Sensing system	Check the Load Sensing PCB is functioning and EN and ALM are opposite. Check wiring from the Load Sensing PCB to the PLC
<b>01A70000</b>	There is a problem with the Mode Select Switch	Check the wiring from the Mode Select Switch to the Cage Node. Replace the Mode Select Switch
<b>01A90000</b>	There is a problem with the Override Switch	Check the wiring from the Override Switch to the PLC Replace the Override Switch

<b>Error Code</b>	<b>Description</b>	<b>Action</b>
<b>01AA0000</b>	The steer switch is sending a left and right signal at the same time	Check the wiring to the Drive Joystick. Replace the Drive Joystick
<b>01AE0000</b>	There is a problem with the signals from the normally closed and normally open contacts of the Base Green Button to the PLC	Ensure contact blocks are securely in position. Check Base Green Button wiring from the switch contacts to the PLC
<b>01AF0000</b>	There is a problem with the signals from the normally closed and normally open contacts of the Cage Green Button to the PLC	Ensure contact blocks are securely in position. Check Cage Green Button wiring from the switch contacts to the PLC
<b>01B10000</b>	The Boom 2 (lower) Paddle was out of the neutral position before the Green Button or Footswitch was pressed	Return the Boom 2 Paddle to the neutral position and release the Green Button and Footswitch. Press the Green Button or Footswitch and then move the Boom 2 Paddle to operate Links
<b>01B20000</b>	The Boom 3 (upper) Paddle was out of the neutral position before the Green Button or Footswitch was pressed	Return the Boom 3 Paddle to the neutral position and release the Green Button and Footswitch. Press the Green Button or Footswitch and then move the Boom 3 Paddle to operate Luffing
<b>01B30000</b>	The Slew Paddle was out of the neutral position before the Green Button or Footswitch was pressed.	Return the Slew Paddle to the neutral position and release the Green Button and Footswitch. Press the Green Button or Footswitch and then move the Slew Paddle to operate Slew
<b>01B40000</b>	The Telescope Paddle was out of the neutral position too long before the Green Button or Footswitch was pressed	Return the Telescope Paddle to neutral and release the Green Button and Footswitch. Press the Green Button or Footswitch and then move the Telescope Paddle to operate Telescope. Check the paddle returns to the neutral position when released. If not, replace the paddle

# **nifty** Height Rider/SP Series

## Operating & Safety Instructions

<b>Error Code</b>	<b>Description</b>	<b>Action</b>
<b>01B60000</b>	The Drive Joystick was out of the neutral position before the Green Button or Footswitch was pressed	Return the Drive Joystick to the neutral position and release the Green Button and Footswitch.  Press the Green Button or Footswitch and then move the Drive Joystick to operate drive
<b>01C20000</b>	The Joystick and PLC are not communicating	Ensure Joystick is plugged in.  Check power and CAN Bus connections to the Drive Joystick
<b>01C30000</b>	The Cage Node and PLC are not communicating	Ensure Cage Node is plugged in  Check power supply and CAN Bus connections to the Cage Node
<b>01C40000</b>	The Motor Controller and PLC are not communicating	Ensure the Motor Controller is plugged in.  Check power supply and CAN Bus connections to the Motor Controller
<b>01C60000</b>	The Right Hand Drive Controller and PLC are not communicating	Ensure the Drive Controller is plugged in.  Check power supply and CAN Bus connections to the Drive Controller
<b>01C70000</b>	The Left Hand Drive Controller and PLC are not communicating	Ensure the Drive Controller is plugged in.  Check power supply and CAN Bus connections to the Drive Controller
<b>01C80000</b>	The Cage Screen and PLC are not communicating	Ensure screen is plugged in.  Check power supply and CAN Bus connections to the Cage Screen
<b>01C90000</b>	The Base Screen and PLC are not communicating	Ensure screen is plugged in.  Check power supply and CAN Bus connections to the Base Screen

<b>Error Code</b>	<b>Description</b>	<b>Action</b>
<b>01CC0000</b>	The Boom 2 Inclination Sensor and PLC are not communicating	Ensure Boom 2 Inclination Sensor is plugged in. Check power supply and CAN Bus connections to the Boom 2 Inclination Sensor
<b>01CD0000</b>	The Boom 3 Inclination Sensor and PLC are not communicating	Ensure Boom 3 Inclination Sensor is plugged in. Check power supply and CAN Bus connections to the Boom 3 Inclination Sensor
<b>01CF0000</b>	The Chassis Inclination Sensor and PLC are not communicating	Ensure Chassis Inclination Sensor is plugged in. Check power supply and CAN Bus connections to the Chassis Inclination Sensor
<b>01D20000</b>	The drive joystick trigger is: being held too long before motion is requested; obstructed; or it has failed	Hold trigger for only a few seconds prior to requesting motion. Remove objects that are obstructing the trigger. Replace the drive joystick
<b>01D30000</b>	The Chassis Inclination Sensor is at an angle side to side across the machine that is too great to allow zero to be set	Move the machine to firm level ground (e.g. Concrete factory floor) before entering the code to zero the Chassis Inclination Sensor
<b>01D40000</b>	The Chassis Inclination Sensor is at an angle between the front and rear of the machine that is too great to allow the zero to be set	Move the machine to firm level ground (e.g. Concrete factory floor) before entering the code to zero the Chassis Inclination Sensor
<b>01E10000</b>	There is a problem with the signal from the Boom 3 (upper) Paddle in the cage	Return the Boom 3 (upper) Paddle to neutral and attempt to operate Boom 3 again. Check the connector to the Boom 3 Paddle is secure. Replace the Boom 3 Paddle
<b>01E20000</b>	There is a problem with the signal from the Boom 2 (lower) Paddle in the cage	Return the Boom 2 Paddle to neutral and attempt to operate Boom 2 again. Check the connector to the Boom 2 Paddle is secure. Replace the Boom 2 Paddle.

**Operating & Safety Instructions**

<b>Error Code</b>	<b>Description</b>	<b>Action</b>
<b>01E30000</b>	There is a problem with the signal from the Slew Paddle in the cage	Return the Slew Paddle to neutral and attempt to operate Slew again. Check the connector to the Slew Paddle is secure. Replace the Slew Paddle
<b>01E50000</b>	There is a problem with the signal from the Telescope Paddle in the cage	Return the Telescope Paddle to neutral and attempt to operate Telescope again. Check the connector to the Telescope Paddle is secure. Replace the Telescope Paddle
<b>01E60000</b>	There is a problem with the signal from the Drive Joystick in the cage	Return the Drive Joystick to neutral and attempt to operate the Joystick again. Check the connector to the Drive Joystick is secure. Replace the Drive Joystick
<b>01F20000</b>	A software parameter is missing or not valid	Cycle the power to the machine
<b>01F30000</b>	The serial number of the machine is incorrect	Check the machine serial plate. Contact a Niftylift approved service centre
<b>01F40000</b>	The PLC is set to download	Move the Test Jumper in the Main Control Box to 0 V (Zero volts)

## Appendix B

### Safety Related Parts of the Control System (SRP/CS)

The Niftylift control system has been designed and validated according to the required standards. The table below lists the safety related parts of the control system and the level to which they have been approved.

The performance level (PL) of each SRP/CS is specified by BS EN 280:2013+A1:2015 section 5.11 Table 5.

Safety Related Part of the Control System (SRP/CS)	Approval (Standard, Performance Level)
<b>A1</b> Prevent travel above inclination limit	BS EN ISO 13849-1:2015 PL c
<b>A2</b> Limitation of travelling speed	BS EN ISO 13849-1:2015 PL c
<b>A3</b> Load sensing system	BS EN ISO 13849-1:2015 PL d
<b>A4</b> Platform levelling	BS EN ISO 13849-1:2015 PL c
<b>A5</b> Interlocking of control positions	BS EN ISO 13849-1:2015 PL c
<b>A6</b> Prevent movements of load holding cylinders in case of pipe failure	BS EN ISO 13849-1:2015 PL c
<b>A7</b> Interlocking of travel controls	BS EN ISO 13849-1:2015 PL b
<b>A8</b> Emergency Stop	BS EN ISO 13850-1:2015 PLd/c
<b>A9</b> SiOPS	BS EN ISO 13849-1:2015 PLd

#### **A1 PREVENT TRAVEL ABOVE INCLINATION LIMIT**

The inclination interlock or Tilt System is PL c in accordance to with BS EN ISO 13849-1:2015 as required by BS EN 280:2013+A1:2015.

*1. The limits of the safety-related parts to the category selected and any fault exclusions;*

The tilt interlock is only active when the telescoping booms are lifted up out of the stowed position.

An inclination sensor on boom 1 measures the angle of the machine chassis.

#### **Proper maintenance and daily safety checks to be observed**

The inclination sensor cannot be overridden to bypass the tilt system other than by demounting the switch with the use of tools. **Reasonably foreseeable misuse**

If the inclination sensor is removed or if it is not maintained in accordance with the appropriated documentation the tilt system may not function in compliance with the requirements as a PL c device.

*2. The limits of the SRP/CS and any fault exclusion, for which, when essential for maintaining the selected category or categories and safety performance, appropriate information (e.g. for modification, maintenance and repair) shall be given to ensure the continued justification of the fault exclusion(s);*

## **Operating & Safety Instructions**

Do not alter, modify or disable in any way the controls, safety devices, interlocks or any other part of the machine.

Maintenance must only be carried out by appropriately trained and competent persons.

### *3.The effects of deviations from the specified performance on the safety function(s);*

If the tilt interlock does not function as intended it is possible that the Niftylift may encounter slopes for which it is not rated.

If the Niftylift encounters slopes beyond the rating as specified on the serial plate the product may occur instability.

If the product becomes unstable, damage to the Niftylift, other equipment and properties, injury or loss of life of the operator and surrounding persons may be a risk.

### *4.Clear descriptions of the interfaces to the SRP/CS and protective devices;*

The tilt system comprises of a primary device the “inclination sensor” and control PCBs, and protective devices, for example solenoid operated hydraulic valves or contactors.

If the drive forward or backwards functions are selected when stowed, the drive functions will be available regardless of angle of inclination.

If the drive forward or backwards functions are selected when not stowed, the output from the inclination sensor not being present will deny drive functions.

### *5.Response time*

The inclination sensor is active at all times providing the correct signal in relation to the angle of inclination of the chassis. In the event of encountering an angle of inclination greater than allowable the system will prevent drive functions from being performed until the booms have been lowered on to the stowed position and the angle of inclination has been corrected.

### *6.Operating limits (including environmental conditions);*

All components within the tilt interlock are rated to the environmental conditions acceptable for the machine; refer to Section 2.2.

### *7.Indications and alarms;*

#### Tilt alarm

The action of the tilt alarm will cause the klaxon to sound and will be indicated by the red warning light on the base and cage location, if the booms are raised and the allowable tilt limit is detected.

### *8.Muting and suspension of safety functions;*

While the inclination sensor is always active the drive interlock is suspended while the booms are in the stowed position. The angle of inclination having been exceeded will be indicated via warning lights regardless of the boom position.

### *9.Control modes;*

The tilt system has no user controllable modes of operation.



*10. Maintenance; Maintenance checklists;*

Normal maintenance

- Visual check of transducers, board (box) and connection wires.
- Check of power supply to verify it is correct.
- Check of the equipment correct operation, by simulating a locked condition and correspondent rearming. See “Means for easy and safe trouble shooting”
- Check correct operation of the inclination sensor.

The inclination sensor will not normally require special maintenance. Should special maintenance be required please observe the following precautions.

- Cut off power supply before every check or replacement.
- Do not weld on machine structure before removing power supply (positive and negative) and detaching boxes from vehicle frame or possible connections towards vehicle frame.
- Provide suitable mechanical protections for connection wires, paying particular attention for transducers.
- Do not place board, transducers or cabling close to sources of heat, electromagnetic interferences or power transmissions.
- Do not touch directly boards, transducers and boxes with flushing or degreaser fluids under pressure.
- Do not make holes in the board box.
- Seal the box and/or the panel who contains the electronic board, to reveal any not authorized access or tampering.

*11. Ease of accessibility and replacing of internal parts;*

Replacement of parts should only be carried out by appropriately trained and competent persons.

If parts require replacement only replace the whole such as Inclination sensor, Safety Switch, PLC or Hydraulic valve block.

Do not attempt to open the inclination sensor or replace components soldered to any PLC.

Do not attempt maintenance of hydraulic components i.e. replace seals or internal components.

Only Niftylift original and supplied parts shall be used.

*12. Means for easy and safe trouble shooting;*

To check the operation of the inclination sensor system

With booms slightly raised, drive onto a slope equal to the rated angle of the machine. The machine brakes should halt the machine as soon as the level is reached.

*13. Information explaining the applications for use relevant to the category to which reference is made;*

Not applicable.

*14. Checking test intervals where relevant.*

Check the operation of the inclination sensor system to be made at the beginning of every duty cycle.

### **A2 LIMITATION OF TRAVELLING SPEED**

The limitation of travelling speed interlock, also known as the elevated drive speed system, is PL c in accordance with BS EN ISO 13849-1:2015 as required by BS EN 280:2013+A1:2015.

*1. The limits of the safety-related parts to the category selected and any fault exclusions;*

The elevated drive speed system is only active when the machine is not in the stowed position.

Two inclination sensors measure the angle of the booms, one on boom 2 and one on boom 3. The base PLC calculates the difference in angle between the two booms to determine if the machine is stowed or not.

Depending on the boom positions the PLC controls if elevated drive speed is selected.

Proper maintenance and daily safety checks to be observed.

The inclination sensor cannot be overridden to bypass the elevated drive system other than by demounting the switches with the use of tools.

If the inclination sensors are removed or are not maintained in accordance with the appropriated documentation the elevated drive speed system may not function in compliance with the requirements as a PL c device.

*2. The limits of the SRP/CS and any fault exclusion, for which, when essential for maintaining the selected category or categories and safety performance, appropriate information (e.g. for modification, maintenance and repair) shall be given to ensure the continued justification of the fault exclusion(s);*

Do not alter, modify or disable in any way the controls, safety devices, interlocks or any other part of the machine.

Maintenance must only be carried on by appropriately trained and competent persons.

*3. The effects of deviations from the specified performance on the safety function(s);*

If the elevated drive speed interlock does not function as intended it is possible that the Niftylift may experience dramatic dynamic effects which may adversely affect the stability of the product.

If the product becomes unstable, damage to the Niftylift, other equipment and properties, injury or loss of life of the operator and surrounding persons may be a risk.

*4. Clear descriptions of the interfaces to the SRP/CS and protective devices;*

The elevated drive speed interlock consists of the inclination sensors a PLC and solenoid operated hydraulic valve.

If the drive forward or backwards functions are selected when the booms are stowed the PLC will allow full speed drive functions. If the drive forward or backwards functions are selected when not stowed the output from the PLC is required to energise the elevated drive valve to reduce the drive speed via the motor controllers.

*5. Response time*

The inclination sensor is active at all times providing the correct signal in relation to the position of the booms. With the booms in the raised position the system will prevent high speed drive functions from being performed until the booms have been lowered.

6. *Operating limits (including environmental conditions);*

All components within the elevated drive speed are rated to the environmental conditions acceptable for the machine; refer to Section 2.2.

7. *Indications and alarms;*

There are no indicators or alarms to show that the Niftylift is under the control of the elevated drive speed interlock.

8. *Muting and suspension of safety functions;*

It is not possible to suspend the operation of the Elevated drive speed interlock with the booms raised.

9. *Control modes;*

The elevated drive speed interlock has no user controllable modes of operation.

10. *Maintenance; Maintenance checklists;*

Normal maintenance

- Check correct operation of the inclination sensors.

11. *Ease of accessibility and replacing of internal parts;*

Replacement of parts should only be carried out by appropriately trained and competent persons.

If parts require replacement only replace the complete item such as Safety Switch, PLC or Hydraulic valve block.

Do not attempt to open the sensors.

Do not attempt maintenance of hydraulic components i.e. replace seals or internal components

Only Niftylift original and supplied parts shall be used.

12. *Means for easy and safe trouble shooting;*

To check the operation of the elevated drive speed system

- 1) Ensure that the Niftylift has sufficient clearance in all directions to drive for a minimum distance to ascertain that the elevated drive speed is correct.
- 2) Power on the Niftylift and select the cage control location.
- 3) From the cage control elevate the booms sufficient to lift the cage above 3m
- 4) By the use of the drive forward and backwards functions in turn, depress the joystick trigger and depress the joystick in the desired direction.
- 5) Observe that the speed of the drive functions is no more than 1km/h.
- 6) Release the joystick to cease driving operations.

13. *Information explaining the applications for use relevant to the category to which reference is made;*

Not applicable

14. *Checking test intervals where relevant.*

Check the operation of the elevated drive system to be made at the beginning of every duty cycle.

## Operating & Safety Instructions

### A3 LOAD SENSING SYSTEM

The Load sensing system is PL d in accordance to with BS EN ISO 13849-1:2015 as required by BS EN 280:2013+A1:2015

*1. The limits of the safety-related parts to the category selected and any fault exclusions;*

The load sensing system is always active. The sensing system is a two-channel device which takes the input from a single load cell bridge on the cage load cell. The actual cage load is determined, and in the case of an overload, the alarm will sound and the output signal is lost.

The loss of the output signal is converted into two separate signals, one of which is used to isolate Channel 1 output (CWEN) and the other to isolate the Channel 2 output. (CWALM). **Proper maintenance and daily safety checks to be observed.**

On initial set-up the machine must be zero loaded to allow the 'Tare' function to register the no-load condition. Following that a calibrated test load is put into the cage to set the upper limit. Proper adherence to the zero set point and the correct test load must be taken to ensure the load sensing system is working correctly. It is possible to apply the overload to the machine in the rest position, and then only to detect this on the next application of the command signal. If the machine has been in the elevated position the consequences of this would be more significant than if the machine were stowed.

#### **Reasonably foreseeable misuse**

*2. The limits of the SRP/CS and any fault exclusion, for which, when essential for maintaining the selected category or categories and safety performance, appropriate information (e.g. for modification, maintenance and repair) shall be given to ensure the continued justification of the fault exclusion(s);*

Do not alter, modify or disable in any way the controls, safety devices, interlocks or any other part of the machine.

Maintenance must only be carried on by appropriately trained and competent persons, who are conversant with all modes of operation, speeds and characteristics of this model.

*3. The effects of deviations from the specified performance on the safety function(s);*

If the load sensing system does not function as intended it is possible that the Niftylift may encounter overloads for which it is not rated.

If the Niftylift encounters loads beyond the rating as specified on the serial plate the product may occur instability.

If the product becomes unstable, damage to the Niftylift, other equipment and properties, injury or loss of life of the operator and surrounding persons may be a risk.

*4. Clear descriptions of the interfaces to the SRP/CS and protective devices;*

The load moment control system comprises of a primary device the "load sensor" and a PLC, and motor controllers.

If the load sensing system cuts out, an alarm will sound and a clear indication of visual overload will be given at each operating position. The system will not re-set until the overload has been removed, by recommendation of reducing the overload in a safe manner.

#### 5. *Response time;*

The Load sensing system is active all the time the green button or footswitch is depressed, the application of an overload will be detected within 4 seconds to cater for transient loads and acceleration forces. The alarm and visual indication will continue to sound as long as the machine is overloaded and the command signal is being applied. Removal of the overload by reduction of the applied load will take the cage weight below the threshold for activation as there is 95% hysteresis in the system. Once restored the load system will function as before and no re-calibration will be necessary.

#### 6. *Operating limits (including environmental conditions);*

All components within the load sensing system are rated to the environmental conditions acceptable for the machine; see **Section 2.2**.

#### 7. *Indications and alarms;*

The action of the cage overload detection will cause the klaxon to sound and will be indicated by the red warning light on the base and cage location, only as long as the green button or footswitch is continued to be depressed.

#### 8. *Muting and suspension of safety functions;*

In the case of the overload being detected the alarm can be silenced by releasing the green button or footswitch. Suspension of the function will continue until the overload has been safely removed.

#### 9. *Control modes;*

The load sensing system has no user controllable modes of operation, other than by use of the calibration tool.

#### 10. *Maintenance; Maintenance checklists;*

Normal maintenance

- Visual check of connection wires.
- Check of power supply to verify it is correct.
- Check of the equipment correct operation, by simulating an overload condition and correspondent re-setting. See "Means for easy and safe trouble shooting"

The load sensor will not normally require special maintenance

Should special maintenance be required please observe the following precautions.

- Cut off power supply before every check or replacement.
- Do not weld on machine structure before removing power supply (positive and negative) and detaching boxes from vehicle frame or possible connections towards vehicle frame.
- Provide suitable mechanical protections for connection wires, paying particular attention for transducers.
- Do not place board, transducers or cabling close to sources of heat, electromagnetic interferences or power transmissions.
- Do not touch directly boards, transducers and boxes with flushing or degreaser fluids under pressure.
- Do not make holes in the board box.
- Seal the box and/or the panel who contains the electronic board, to reveal any not authorized access or tampering.

## **Operating & Safety Instructions**

### *11. Ease of accessibility and replacing of internal parts;*

Replacement of parts should only be carried out by appropriately trained and competent persons.

If parts require replacement only replace the whole such as Load Sensor, PLC, PCB or Hydraulic valve block.

Do not attempt to open the load sensing PCB or replace components soldered to any PCB.

Do not attempt maintenance of hydraulic components i.e. replace seals or internal component.

Only Niftylift original and supplied parts shall be used.

### *12. Means for easy and safe trouble shooting;*

To check the operation of the load sensor system

1. Power on the Niftylift and select the base control location.
2. Allow the power circuits to cycle and ensure the machine is ready for the command signal.
3. Press the base green button and observe that the machine is ready to function with no load in the cage. (Machine runs, pump flow is available for machine functions, drive functions)
4. Select the Cage control position and mount into the cage.
5. Enable the cage controls and then press the cage green button or foot switch to enable the machine functions. (Machine runs, pump flow is available for machine operation.)
6. Add sufficient load to the cage to exceed the safe working load. Press the green button or foot switch and observe that the cage overload system brings in the alarm and halts all machine movements.
7. Remove the overload to below the threshold for safe working load and observe that the cage load control automatically re-sets and restores all machine functions.
8. Power off the Niftylift.

### *13. Information explaining the applications for use relevant to the category to which reference is made;*

Not applicable

### *14. Checking test intervals where relevant.*

Check the operation of the load sensing system to be made at the beginning of every duty cycle.

## **A4 PLATFORM LEVELLING**

The Platform levelling system is PL c in accordance to with BS EN ISO 13849-1:2015 as required by BS EN 280:2013+A1:2015

*1.The limits of the safety-related parts to the category selected and any fault exclusions;*

The Platform levelling system comprises of a load holding device mounted to the slave levelling cylinder.

*2.The limits of the SRP/CS and any fault exclusion, for which, when essential for maintaining the selected category or categories and safety performance, appropriate information (e.g. for modification, maintenance and repair) shall be given to ensure the continued justification of the fault exclusion(s);*

Do not alter, modify or disable in any way the controls, safety devices, interlocks or any other part of the machine.

In the event of a hose failure ensure a recovery plan is in place that does not require the movement of the luffing booms as the angle of the cage will not be maintained. See effect of deviations from the specified performance below.

Maintenance must only be carried on by appropriately trained and competent persons.

*3.The effects of deviations from the specified performance on the safety function(s);*

If the levelling system of the product does not function as intended the angle of the cage may not be maintained.

If the angle of cage is not maintained there is an increased risk of ejection of tools and equipment from the cage;

In the event of the operator or other occupants of the cage not using the required safety equipment they may be ejected from the cage and serious injury or death may occur.

There is a load holding device contained within the assembly of the slave levelling cylinder such that if a hose fails the cage position is maintained until the operator can be recovered from the cage.

*4.Clear descriptions of the interfaces to the SRP/CS and protective devices;*

The levelling system comprises of two hydraulic cylinders and interconnecting hoses.

One is referred to as the Master levelling cylinder

The other is referred to as the Slave levelling cylinder.

In normal operation when the luffing booms are elevated the master levelling cylinder responds to the movement of the booms and causes a transfer of hydraulic fluid to the appropriate side of the slave levelling cylinder.

This transfer of hydraulic fluid maintains the level aspect of the cage.

*5.Response time*

The Levelling system is a direct acting hydraulic system and as such the response time is near instantaneous.

## **Operating & Safety Instructions**

### *6. Operating limits (including environmental conditions);*

All components within the platform levelling system are rated to the environmental conditions acceptable for the machine; see **Section 2.2**.

### *7. Indications and alarms;*

There are no indicators or alarms to show that the Niftylift levelling system is functioning.

### *8. Muting and suspension of safety functions;*

It is not possible to suspend the operation of the levelling system.

### *9. Control modes;*

The levelling system has two modes of operation

- 1) Normal movements of the luffing booms cause the system to constantly adjust the cage angle to keep it level.
- 2) Manual adjustment to account for drift of the system over time.

### *10. Maintenance; Maintenance checklists;*

Normal maintenance

- Removal of air from the hydraulic system if the product is left unused for long periods of time.

### *11. Ease of accessibility and replacing of internal parts;*

Replacement of parts should only be carried out by appropriately trained and competent persons.

If parts require replacement only replace the whole components such as hoses, hydraulic cylinders or load holding and over centre valve.

Do not attempt maintenance of hydraulic components i.e. replace seals or internal component.

Only Niftylift original and supplied parts shall be used.

### *12. Means for easy and safe trouble shooting;*

Elevate the luffing booms and check that the cage remains level. If the cage does not remain level the system should be serviced by trained persons fully conversant with the function of the system.

### *13. Information explaining the applications for use relevant to the category to which reference is made;*

Not applicable

### *14. Checking test intervals where relevant.*

Check the operation of the cage levelling system to be made at the beginning of every duty cycle.



## **A5 INTERLOCKING OF CONTROL POSITIONS**

The interlocking of the control positions is PL c in accordance to with BS EN ISO 13849-1:2015 as required by BS EN 280:2013+A1:2015

*1. The limits of the safety-related parts to the category selected and any fault exclusions;*

The physical interlocks between the multiple control positions are controlled through primarily electrical means such that neither position takes sole command unless selected. The alternate control position is then rendered inoperative by isolation of that control circuit. **Proper maintenance and daily safety checks to be observed.**

Since the physical installation of the electrical contacts is the means by which the control circuit operates it is imperative that the functionality is retained. If the internal wiring is interfered with the control isolation could be lost or altered in a way that promotes a dangerous mode of operation. **Reasonably foreseeable misuse**

*2. The limits of the SRP/CS and any fault exclusion, for which, when essential for maintaining the selected category or categories and safety performance, appropriate information (e.g. for modification, maintenance and repair) shall be given to ensure the continued justification of the fault exclusion(s);*

Do not alter, modify or disable in any way the controls, safety devices, interlocks or any other part of the machine.

Maintenance must only be carried on by appropriately trained and competent persons, who are conversant with all modes of operation, speeds and characteristics of this model.

*3. The effects of deviations from the specified performance on the safety function(s);*

If the interlocking of the control positions does not function as intended it is possible that the Niftylift may allow modes of operation that render it potentially dangerous.

If the controls do not remain independent in their operation, damage to the Niftylift, other equipment and properties, injury or loss of life of the operator and surrounding persons may be a risk.

*4. Clear descriptions of the interfaces to the SRP/CS and protective devices;*

Each control position is capable of being energised by means of a key operated 'mode selector' which electrically isolates the other circuit when one is selected. The reliability of this function depends on the correct device operator in conjunction with the appropriate contact and internal wiring.

*5. Response time*

Operation of the mode selector key switch is immediate. Control authority is transferred over and no residual power functions remain with the alternate control position.

*6. Operating limits (including environmental conditions);*

All components within the control interlock system are rated to the environmental conditions acceptable for the machine; see **Section 2.2.**

*7. Indications and alarms;*

None, other than by key position.

*8. Muting and suspension of safety functions;*

None.

## **Operating & Safety Instructions**

### *9. Control modes;*

The control circuit will permit independent operation of either control position with the key positions: OFF, BASE and CAGE.

### *10. Maintenance; Maintenance checklists;*

Normal maintenance

- Visual check of switch operators, (Key switch) and connection wires.
- Check of power supply to verify it is correct.
- Check of the equipment correct operation, by selection of the alternate control position and then checking that the green button is inert at the non-selected position.

### *11. Ease of accessibility and replacing of internal parts;*

Replacement of parts should only be carried out by appropriately trained and competent persons.

Individual parts of the control devices can be replaced, ensuring like-for-like exchange of parts, security of the wiring and polarity of components if applicable (Diode outputs etc.)

**Only Niftylift original parts shall be used.**

### *12. Means for easy and safe trouble shooting;*

To check the operation of the load sensor system.

1. Power on the Niftylift and select the base control location.
2. Allow the power circuits to cycle and ensure the machine is ready for the command signal.
3. Press the base green button and observe that the machine is ready to function with no load in the cage. (Machine runs, pump flow is available for machine functions.)
4. Leave the base key in the ground control position and mount into the cage.
5. Enable the cage controls and then press the cage green button or foot switch to enable the machine functions. Check that no controls are active and that no functions are permitted with the key in the 'ground' control position.
6. Have the base key switch position altered to the Cage position. Check that the control functions are now transferred to the cage, and that all controls are active.
7. Dismount from the cage and check the ground controls are now inoperative. All checks are then complete.
8. Power off the Niftylift.

### *13. Information explaining the applications for use relevant to the category to which reference is made;*

Not applicable

### *14. Checking test intervals where relevant.*

Check the operation of the control position interlock to be made at the beginning of every duty cycle.

## **A6 PREVENT MOVEMENTS OF LOAD HOLDING CYLINDERS IN CASE OF PIPE FAILURE**

The load holding system is PL c in accordance to with BS EN ISO 13849-1:2015 as required by BS EN 280:2013+A1:2015

*1.The limits of the safety-related parts to the category selected and any fault exclusions;*

The load holding system comprises of a load holding device mounted to the cylinder.

*2.The limits of the SRP/CS and any fault exclusion, for which, when essential for maintaining the selected category or categories and safety performance, appropriate information (e.g. for modification, maintenance and repair) shall be given to ensure the continued justification of the fault exclusion(s);*

Do not alter, modify or disable in any way the controls, safety devices, interlocks or any other part of the machine.

In the event of a hose failure ensure a recovery plan is in place that does not require the movement of the affected cylinder. A safe route of recovery might involve the replacement in-situ of the failed hose before further movement of the machine is possible.

Maintenance must only be carried on by appropriately trained and competent persons.

*3.The effects of deviations from the specified performance on the safety function(s);*

If the load holding system of the product does not function as intended the angle of the booms may not be maintained.

If the angle of cage is not maintained there is an increased risk of ejection of tools and equipment from the cage;

In the event of the operator or other occupants of the cage not using the required safety equipment they may be ejected from the cage and serious injury or death may occur.

There is a load holding device contained within the assembly of the slave levelling cylinder such that if a hose fails the cage position is maintained until the operator can be recovered from the cage.

*4.Clear descriptions of the interfaces to the SRP/CS and protective devices;*

The load holding system comprises of a pilot operated over centre valve on each load holding cylinder.

The opening of the load holding valve is dependent on the application of a pilot pressure in the descent line to bring the machine down. Excessive over pressure either by overload or thermal expansion can induce an over centre pilot descent until the excess pressure condition is removed.

*5.Response time*

The load holding system is a direct acting hydraulic system and as such the response time is near instantaneous.

## **Operating & Safety Instructions**

### *6. Operating limits (including environmental conditions);*

All components within the load holding system are rated to the environmental conditions acceptable for the machine; see **Section 2.2**.

### *7. Indications and alarms;*

There are no indicators or alarms to show that the Niftylift load holding system is functioning.

### *8. Muting and suspension of safety functions;*

It is not possible to suspend the operation of the load holding system.

### *9. Control modes;*

The load holding system has two modes of operation

- 1) Normal movements of the booms cause the system to constantly adjust the cylinders to maintain machine position and load holding.
- 2) Manual adjustment to recover the machine under emergency conditions.

### *10. Maintenance; Maintenance checklists;*

Normal maintenance

- Removal of air from the hydraulic system if the product is left unused for long periods of time.

### *11. Ease of accessibility and replacing of internal parts;*

Replacement of parts should only be carried out by appropriately trained and competent persons.

If parts require replacement only replace the whole components such as hoses, hydraulic cylinders or load holding and over centre valve.

Do not attempt maintenance of hydraulic components i.e. replace seals or internal components

Only Niftylift original and supplied parts shall be used.

### *12. Means for easy and safe trouble shooting;*

Elevate the luffing booms and check that the cage remains level and the booms remain in their elevated position. If the cage does not remain level the system should be serviced by trained persons fully conversant with the function of the system.

### *13. Information explaining the applications for use relevant to the category to which reference is made;*

Not applicable

### *14. Checking test intervals where relevant.*

Check the operation of the load holding system to be made at the beginning of every duty cycle.

## **A7 INTERLOCKING OF TRAVEL CONTROLS**

The interlocking of the control positions is PL b in accordance to with BS EN ISO 13849-1:2015 as required by BS EN 280:2013+A1:2015

*1. The limits of the safety-related parts to the category selected and any fault exclusions;*

The interlock to prevent simultaneous operation of the booms and travel controls consists of a PLC which checks all cage controls. The PLC which controls the outputs does not allow a booms and a drive function to operate simultaneously. **Proper maintenance and daily safety checks to be observed.**

*2. The limits of the SRP/CS and any fault exclusion, for which, when essential for maintaining the selected category or categories and safety performance, appropriate information (e.g. for modification, maintenance and repair) shall be given to ensure the continued justification of the fault exclusion(s);*

Do not alter, modify or disable in any way the controls, safety devices, interlocks or any other part of the machine.

Maintenance must only be carried out by appropriately trained and competent persons, who are conversant with all modes of operation, speeds and characteristics of this model.

*3. The effects of deviations from the specified performance on the safety function(s);*

If the interlocking of the travel controls does not function as intended it is possible that the Niftylift may allow modes of operation that render it potentially dangerous.

If the controls do not remain independent in their operation, damage to the Niftylift, other equipment and properties, injury or loss of life of the operator and surrounding persons may be a risk.

*4. Clear descriptions of the interfaces to the SRP/CS and protective devices;*

The PLC that controls the boom or travel controls is located in the superstructure of the machine.

*5. Response time*

Loss of the boom functions is immediate as soon as a drive or steer function is selected.

*6. Operating limits (including environmental conditions);*

All components within the travel control interlock system are rated to the environmental conditions acceptable for the machine; see **Section 2.2**

*7. Indications and alarms;*

None.

*8. Muting and suspension of safety functions;*

None.

*9. Control modes;*

Either drive or booms operation modes are available.

## **Operating & Safety Instructions**

### *10. Maintenance; Maintenance checklists;*

Normal maintenance

- Visual check of all levers including the mechanical links from the levers to the valve spools.
- Ensure the smooth and uninterrupted operation of Drive controls.
- Check the loss of functions for all boom movements with the machine drive functions are operated and held to one end of travel. No boom functions should be available if any drive function is operated. Repeat for drive, but when doing so, be aware of the possibility of the machine moving as the control functions are checked. This should be performed in a clear, open area.

### *11. Ease of accessibility and replacing of internal parts;*

Replacement of parts should only be carried out by appropriately trained and competent persons.

Only Niftylift original and supplied parts shall be used.

### *12. Means for easy and safe trouble shooting;*

To check the operation of the travel control interlock.

1. Power on the Niftylift and select the cage control location.
2. Allow the power circuits to cycle and ensure the machine is ready for the command signal.
3. Press the base green button and operate a boom function to raise.
4. At the same time, operate the trigger and steer the drive wheels in one direction or the other.
5. Observe that the boom control function is lost and does not return until the steer lever is released.
6. In a clear area, repeat for a drive forward/ drive backward lever function whilst operating a boom raise command.
7. Observe that the boom control function is lost and does not return until the drive lever is released.
8. Power off the Niftylift.

### *13. Information explaining the applications for use relevant to the category to which reference is made;*

Not applicable

### *14. Checking test intervals where relevant.*

Check the operation of the travel control interlock to be made at every service interval.

## **A8 EMERGENCY STOP SYSTEM**

The Emergency stop system is PL c in accordance to with BS EN ISO 13850:2015 as required by BS EN 280:2013+A1:2015.

*1. The limits of the safety-related parts to the category selected and any fault exclusions;*

There is a 2 channel input from both a base E-stop and a cage E-stop button into the base PLC. Each button operates a normally open and a normally closed switch contact. The failure mode of “Will not open” for the NC contact is excluded. If either E-stop button is pressed by the operator the base PLC ceases all machine movement.

### **Reasonably foreseeable misuse**

*2. The limits of the SRP/CS and any fault exclusion, for which, when essential for maintaining the selected category or categories and safety performance, appropriate information (e.g. for modification, maintenance and repair) shall be given to ensure the continued justification of the fault exclusion(s);*

Do not alter, modify or disable in any way the controls, safety devices, interlocks or any other part of the machine.

Maintenance must only be carried on by appropriately trained and competent persons, who are conversant with all modes of operation, speeds and characteristics of this model.

*3. The effects of deviations from the specified performance on the safety function(s);*

If the Emergency stop system does not function as intended it is possible that the Niftylift may function when the E-stop is pressed.

If the product moves unexpectedly, damage to the Niftylift, other equipment and properties, injury or loss of life of the operator and surrounding persons may be a risk.

*4. Clear descriptions of the interfaces to the SRP/CS and protective devices;*

The Emergency stop system comprises of a primary devices the 2 Emergency stop button and a PLC, and motor controllers.

If the E-stop system is activated the system will not re-set until the button has been released.

*5. Response time;*

Operating the emergency stop is immediate

*6. Operating limits (including environmental conditions);*

All components within the emergency stop system are rated to the environmental conditions acceptable for the machine; see **Section 2.2**.

*7. Indications and alarms;*

When activated the emergency stop button remain visually in an operated position

*8. Muting and suspension of safety functions;*

If the E-stop button in the cage is operated the operator at the base may override this E-stop by changing the control location to the base using the key switch located at the base. The cage operator may then release the E-stop and operate it again to disable drive and boom functions.

## **Operating & Safety Instructions**

### *9. Control modes;*

The emergency stop system has no user controllable modes of operation.

### *10. Maintenance; Maintenance checklists;*

Normal maintenance

- Visual check of connection wires.
- Check of power supply to verify it is correct.
- Check of the equipment correct operation, by simulating an emergency stop. See “Means for easy and safe trouble shooting”

The emergency stop will not normally require special maintenance.

Should special maintenance be require please observe the following precautions.

- Cut off power supply before every check or replacement.
- Do not weld on machine structure before removing power supply (positive and negative) and detaching boxes from vehicle frame or possible connections towards vehicle frame.
- Provide suitable mechanical protections for connection wires, paying particular attention for transducers.
- Do not place board, transducers or cabling close to sources of heat, electromagnetic interferences or power transmissions.
- Do not touch directly boards, transducers and boxes with flushing or degreaser fluids under pressure.
- Do not pierce the board box.
- Seal the box and/or the panel who contains the electronic board, to reveal any not authorized access or tampering.

### *11. Ease of accessibility and replacing of internal parts;*

Replacement of parts should only be carried out by appropriately trained and competent persons.

If parts require replacement only replace the complete item such as the contact blocks, PLC, or Hydraulic valve block.

Do not attempt to open the main base PLC or replace components soldered to any PCB.

Do not attempt maintenance of hydraulic components i.e. replace seals or internal component.

Only Niftylift original and supplied parts shall be used.

### *12. Means for easy and safe trouble shooting;*

To check the operation of the emergency stop system

1. Power on the Niftylift and select the base control location.
2. Allow the power circuits to cycle and ensure the machine is ready for the command signal.
3. Press the base green button and observe that the machine is ready to function with no load in the cage. (Machine runs, pump flow is available for machine functions.)
4. Select the Cage control position and mount into the cage.
5. Enable the cage controls and then press the cage green button or foot switch to enable the machine functions. (Machine runs, pump flow is available for machine operation.)



6. Press the cage emergency stop button. Press the green button or foot switch and observe that machine movements have been halted
7. Release the cage emergency stop button, switch the controls to the base and repeat for the base emergency stop button.
8. Power off the Niftylift.

*13. Information explaining the applications for use relevant to the category to which reference is made;*

Not applicable

*14. Checking test intervals where relevant.*

Check the operation of the emergency stop system to be made at the beginning of every duty cycle.

## **Operating & Safety Instructions**

---

### **A9 SiOPS**

The Sustained Involuntary Operation Prevention System (SiOPS) is provided in accordance with BS EN ISO 13849-1:2015 as required by BS EN 280:2013+A1:2015

*1. The limits of the safety-related parts to the category selected and any fault exclusions;*

The SiOPS is always active. The system input is a two-channel which takes the signal from the cage console, the console position is determined, and in the case of an involuntary operation, machine function ceases

**Proper maintenance and daily safety checks to be observed.**

*2. The limits of the SRP/CS and any fault exclusion, for which, when essential for maintaining the selected category or categories and safety performance, appropriate information (e.g. for modification, maintenance and repair) shall be given to ensure the continued justification of the fault exclusion(s);*

Do not alter, modify or disable in any way the controls, safety devices, interlocks or any other part of the machine.

Maintenance must only be carried on by appropriately trained and competent persons, who are conversant with all modes of operation, speeds and characteristics of this model.

*3. The effects of deviations from the specified performance on the safety function(s);*

If the SiOPS does not function as intended it is possible that the operator or operators may be exposed to a crushing hazard

If the operator or operators experience a crushing hazard they may be subject to severe injury or loss of life.

*4. Clear descriptions of the interfaces to the SRP/CS and protective devices;*

The SiOPS comprises of a primary device the “console switches” and a PLC, and motor controllers.

If SiOPS is triggered the machine function will stop.

*5. Response time;*

The SiOPS system is always active when the machine is in use

*6. Operating limits (including environmental conditions);*

All components within the SiOPS are rated to the environmental conditions acceptable for the machine; see **Section 2.2**.

*7. Indications and alarms;*

The action of the SiOPS will cause the klaxon to sound and will be indicated by the blue warning light on the cage location.

*8. Muting and suspension of safety functions;*

In the case of the SiOPS being detected the alarm can be silenced by releasing the green button or footswitch. Suspension of the function will continue until the green button is released

*9. Control modes;*

The SiOPS system has no user controllable modes of operation, other than when an operator activates the SiOPS system.

*10. Maintenance; Maintenance checklists;*

Normal maintenance

- Visual check of connection wires.
- Check of power supply to verify it is correct.
- Check of the equipment correct operation, by simulating a SiOPS condition and correspondent re-setting. See “12. Means for easy and safe trouble shooting”

The switches will not normally require special maintenance

Should special maintenance be required please observe the following precautions.

- Cut off power supply before every check or replacement.
- Do not weld on machine structure before removing power supply (positive and negative) and detaching boxes from vehicle frame or possible connections towards vehicle frame.
- Provide suitable mechanical protections for connection wires, paying particular attention for transducers.
- Do not place board, transducers or cabling close to sources of heat, electromagnetic interferences or power transmissions.
- Do not touch directly boards, transducers and boxes with flushing or degreaser fluids under pressure.
- Do not make holes in the board box.
- Seal the box and/or the panel who contains the electronic board, to reveal any not authorized access or tampering.

*11. Ease of accessibility and replacing of internal parts;*

Replacement of parts should only be carried out by appropriately trained and competent persons.

If parts require replacement only replace the whole such as input switch, PLC, PCB. Do not attempt to open the PLC or replace components soldered to any PCB.

Do not attempt maintenance of hydraulic components i.e. replace seals or internal component.

Only Niftylift original and supplied parts shall be used.

*12. Means for easy and safe trouble shooting;*

To check the operation of the SiOPS system

1. Power on the Niftylift and select the cage control station.
2. Allow the power circuits to cycle and ensure the machine is ready for the command signal.
3. Press the cage foot switch or cage green button and operate the machine functions from the cage. (Machine runs, pump flow is available for machine functions, drive functions)
4. Whilst operating the machine from the cage foot switch or cage green button, apply pressure to the cage console and observe that the functions will stop operating. With the pressure being applied to the cage console, both the cage and the base green buttons should be flashing green.
5. If the pressure remains applied to the cage console for 15 seconds observe that the klaxon sounds and the blue warning light flashes.
6. Check that the machine functions (Machine runs, pump flow is available for machine operation) are not available.

### **Operating & Safety Instructions**

7. To check the SiOPS override functionality from the cage controls, while maintaining pressure on the cage console, release either the footswitch or cage green button and then re-press the footswitch or cage green button. Machine functions will return (Machine runs, pump flow is available for machine operation.)
  8. To check the SiOPS override functionality from the base controls. Repeat steps 4, 5 and 6 with a second operator, select the base control station. While maintaining pressure on the cage console, press base green button. Machine functions will return (Machine runs, pump flow is available for machine operation.)
  9. Remove the pressure from the cage console and observe that the flashing green buttons, the klaxon and the blue warning light should stop. Normal operation will be returned.
  10. Power off the Niftylift.
- 13. Information explaining the applications for use relevant to the category to which reference is made;*
- Not applicable
- 14. Checking test intervals where relevant.*
- Check the operation of the SiOPS system to be made at the beginning of every duty cycle.
- 15. Proof testing*
- This two channel system must be proof tested to identify unrevealed failures every six months by a competent person with appropriate safety function experience.

***niftylift***